

VOLVO

242
244
245



year model 1979

Owner's Manual

Presentation



This manual contains instructions on how to drive and maintain your Volvo 242/244/245

It may also contain information not directly related to your particular model since variations can occur from market to market and even between model versions.

Should you require more detailed information concerning adjustments or repairs to your car, please refer to our service manuals, which can be obtained from your Volvo dealer.

If you should take up residence in another country, find out about regulations concerning import and inspection of cars in the country you are moving to. Legislation can differ considerably from country to country. Adapting your car to meet legal requirements can involve considerable costs.

The specifications and constructional data as well as the illustrations contained in this manual are not binding. We reserve the right to make alterations without prior notification.



Number tag

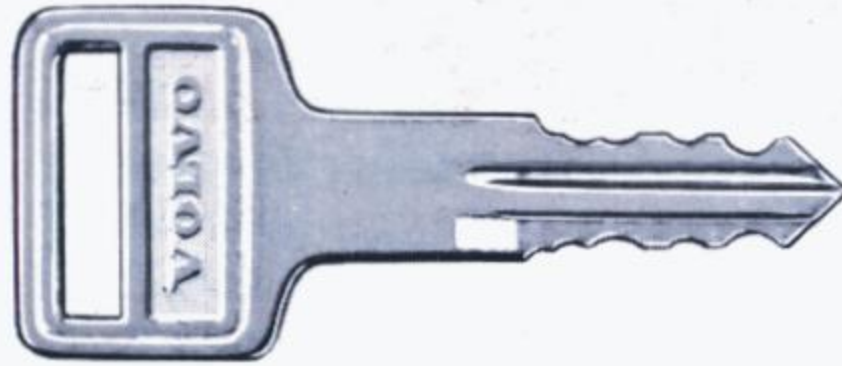

**Boot lid (242, 244)
Tailgate (245)
Glove compartment**

Note the number on your keys in your pocket diary or on a slip of paper which you can keep in, e.g., your wallet or handbag.

The door and ignition switch/steering wheel lock key number is stamped on the separate tag supplied with the keys. This tag should be separated from the key ring.

Should you lose a key, you can order a new one from a Volvo dealer.

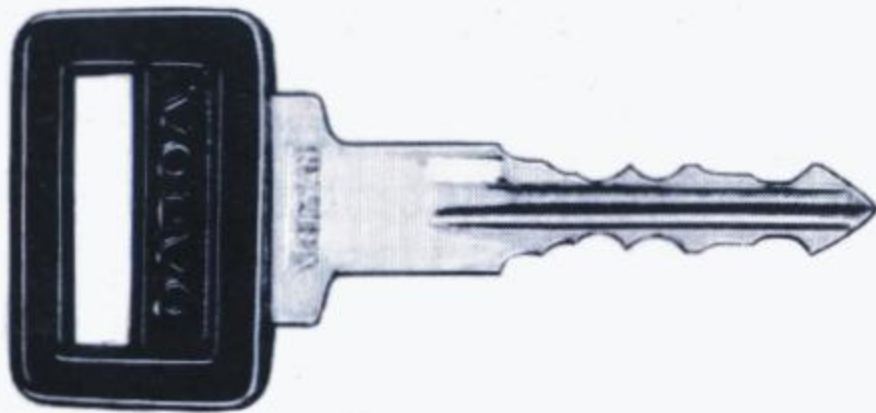

**Doors
Ignition switch/steering wheel lock**

Instruments, switches and controls

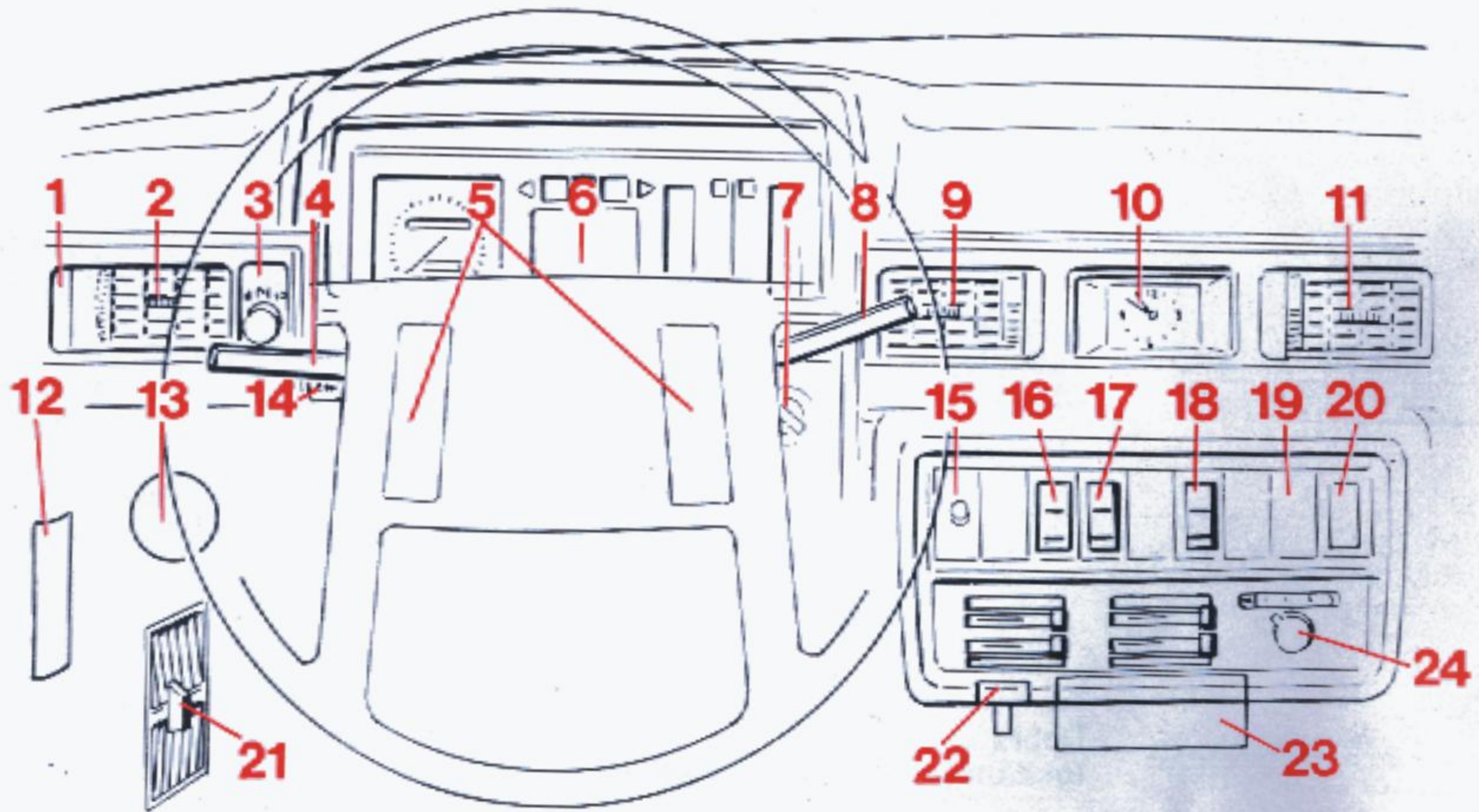

	Described on page
1 Defroster vent, side window	14
2 Air vent	15
3 Headlights and day running lights	9
4 Stalk for direction indicators, headlight dipper and flasher	8
5 Horn	6
6 Instrument panel	8
7 Ignition switch, steering wheel lock	10
8 Windscreen, headlamp wipe ¹⁾ , tailgate window wipe/wash 245	15
9 Air vent	12
10 Clock	15
11 Air vent	57
12 Fuse box	26
13 Bonnet release	13
14 Choke (only carburettor engine)	9
15 Panel illumination knob	11
16 Rear fog lights (certain markets)	11
17 Heated rear window	11
18 Switch for hazard warning lights	17
19 Air conditioning (optional equipment)	22
20 Fasten seat belts light	15
21 Air vent (one on each side)	12
22 Cigar lighter	12
23 Ashtray	14, 16
24 Heater controls	

¹⁾ Headlamp wipe, Great Britain only.

Pages 6–17 contain a detailed description of all the car's instruments and controls.

Please note that variations are possible between the various markets, due, among other factors, to varying legislation.

The five warning lights on this page should never go on when driving

But they should go on when the ignition is switched on before the engine starts. This tells you whether the lights are functioning or not. All the lights should go out when the engine starts (the parking brake light does not, of course, go out until you release the parking brake).

D Parking brake light



This goes on when the parking brake between the front seats is applied.

F Brake circuits failure warning light



If this light goes on when driving and the brake pedal feels spongy, then one of the footbrake circuits is not functioning. However, the car can be driven — but with due care — to a workshop for a check on the brake circuits.

H Oil-pressure failure light



If this light goes on when driving, then the engine oil pressure is too low. Stop the engine immediately and check the oil level in the engine, see page 44.

It can happen that the light goes on after very hard driving, when the engine goes down to idling. This is normal providing that it goes out when the engine speed is increased.

I Battery charging failure light



This light goes on when the alternator is not charging.

Note that if the fan belts slip off or if the fan-belt tension is so poor that the alternator does not charge, **not only will this light go on but also warning lights D, F and M.**

This is due to particular legislation on certain markets and is therefore **quite normal.**

M Bulb failure warning light



This light goes on if any of the following bulbs are out of order:

- day running lights (Great Britain)
- dipped beams
- rear lights
- brake lights (the brake circuits failure warning light goes on each time the brake pedal is depressed)

See pages 52–56 for changing these bulbs.

Should the warning light go on after a defective outside bulb has been replaced with a new one, replace also the corresponding bulb on the other side of the car.

Ignition switch/steering wheel lock, direction indicator stalk

Ignition switch/steering wheel lock



Lock position: Steering wheel locks when key is removed.



Intermediate position: Certain electrical components (e.g., heater fan, cigar lighter) can now be operated.



Engine-running position: The key is in this position when the engine is running.



Start position: Turn the key to this position to start the engine. Release the key as soon as the engine starts. It automatically springs back to the "engine-running position".

If difficulty is found in turning the ignition key, turn the steering wheel a little to the left and then to the right.

A buzzer sounds if the key is in the ignition switch/steering wheel lock (or if the parking lights or headlights are on) and the driver's door is open.

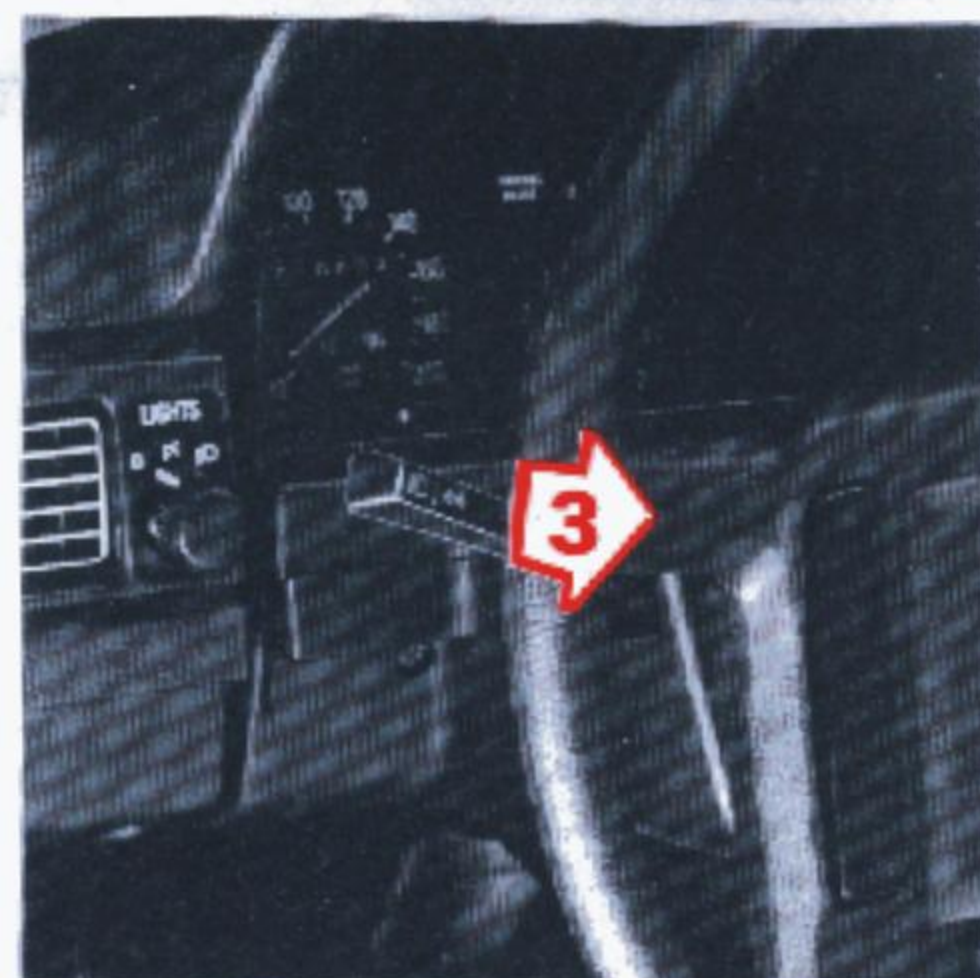
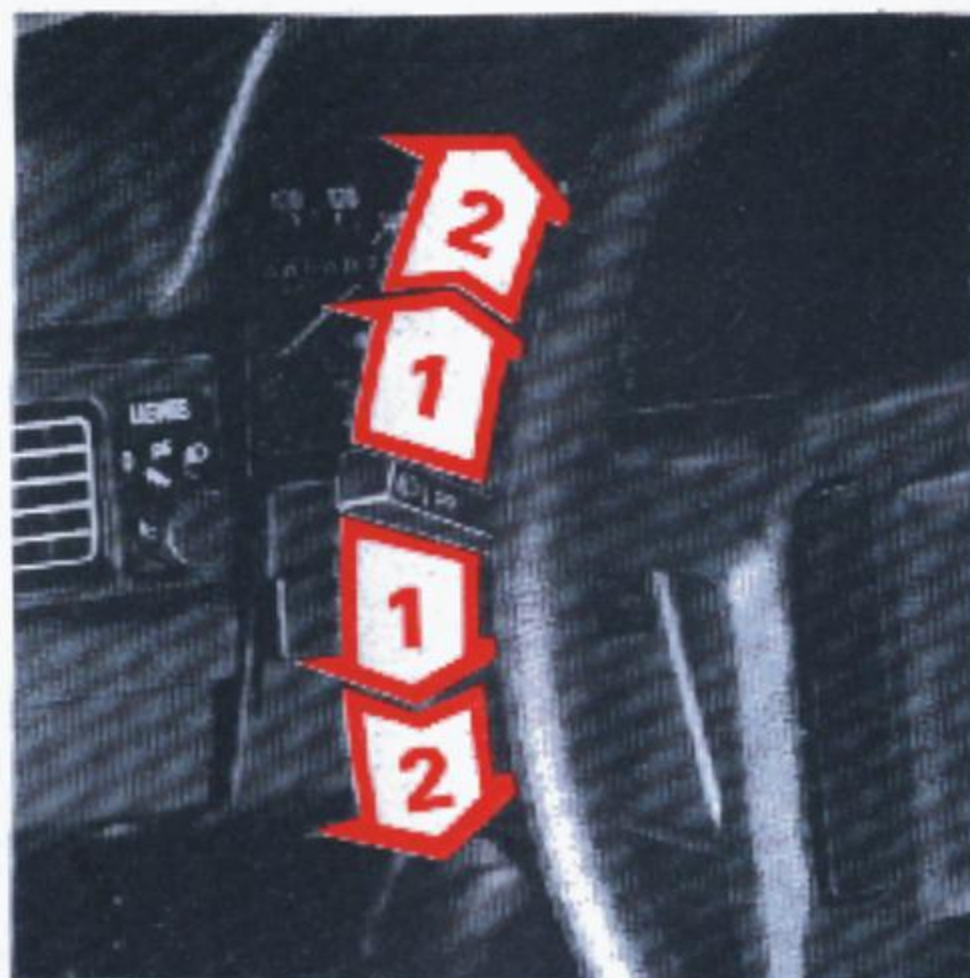

Stalk for direction indicators, fullbeams/dipped beams and headlight flasher

1 Lane-changing, overtaking

Move the lever a bit up or down, and hold it there, when indicating a change of lane or when overtaking. The stalk will return to the neutral-position when released.

2 Normal turns

If a direction indicator bulb becomes defective, the other direction indicator bulb will blink more rapidly than usual.

3 Fullbeams/dipped beams (headlights switched on)

Move the lever towards the rim of the steering wheel and then release it.

3 Headlight flasher (headlights switched off)

Move the lever towards the rim of the steering wheel. Fullbeams remain on until you release the lever.

Headlights switch, panel illumination knob

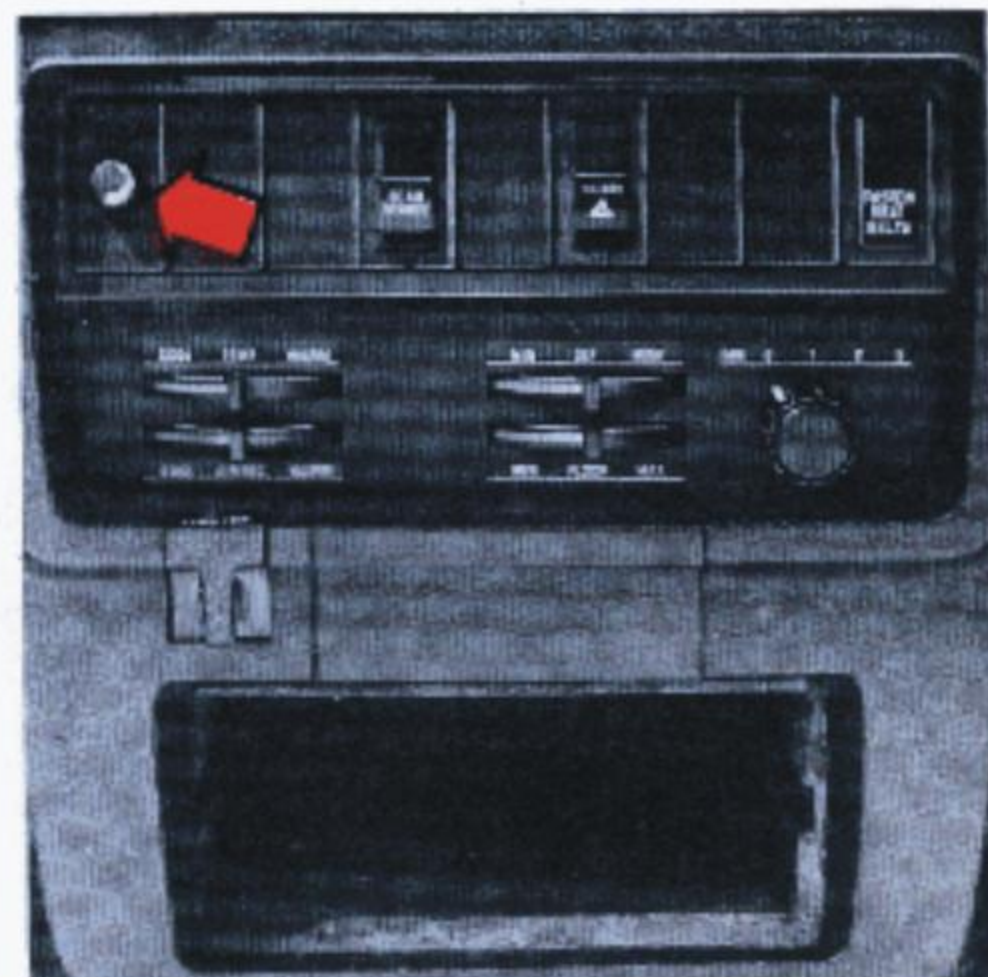
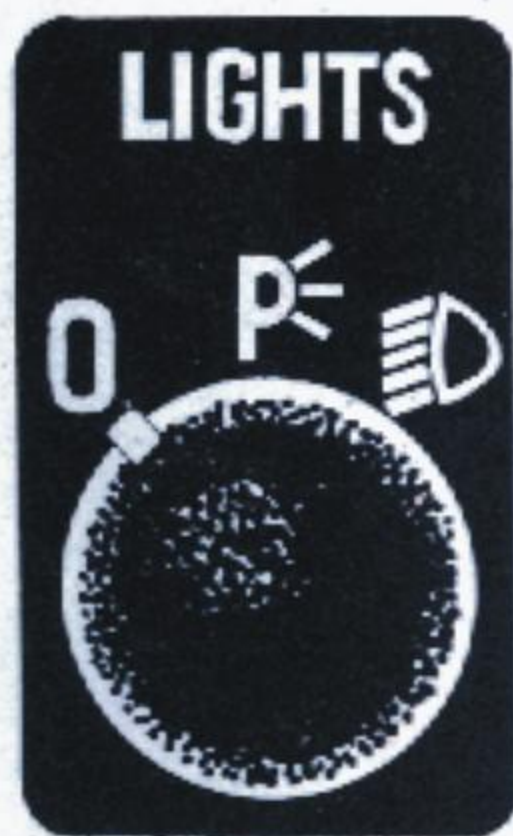
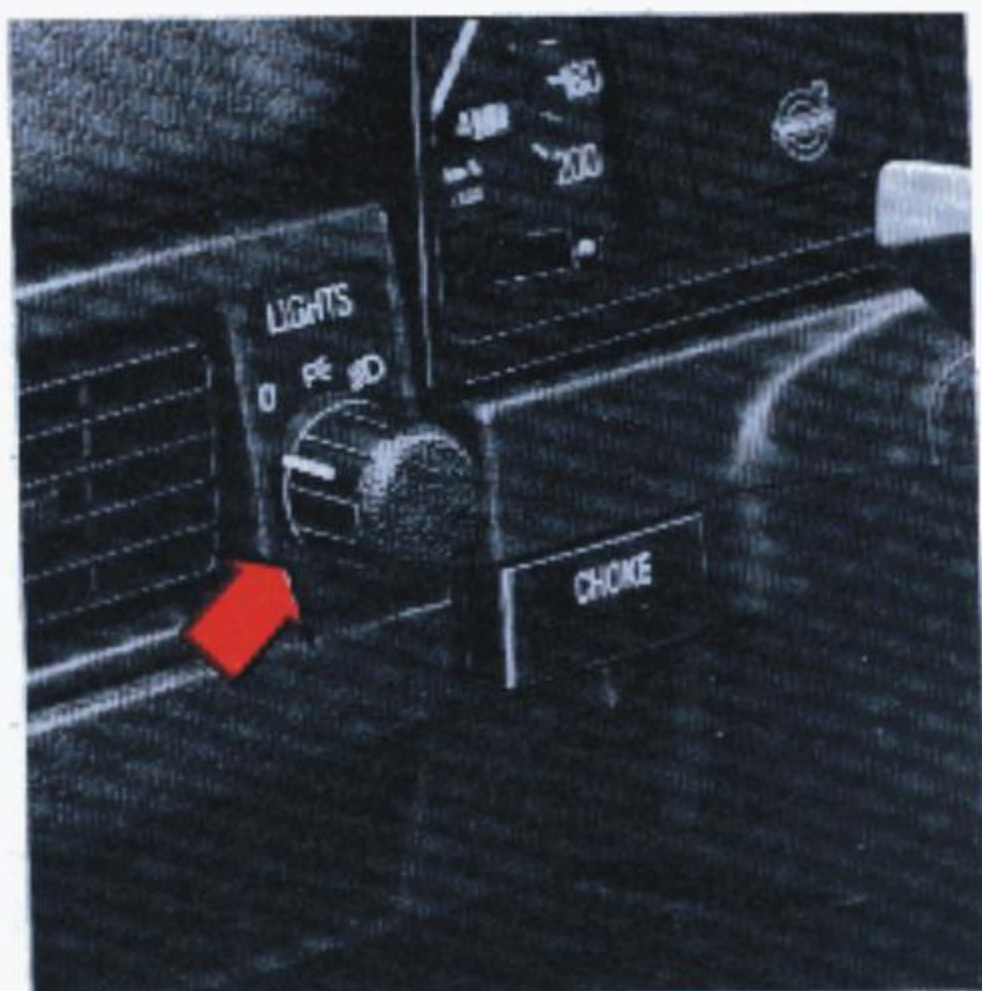

Headlights and day running lights

0 Ignition switched off: All lights off.
Ignition switched on: Day running lights (front and rear) on.

Day running lights go on automatically when the engine is running and cannot, therefore, be switched off by themselves.

These lights are used when driving in daylight and on well-lit streets and roads when it is dark. In the event the day running lights must not be on during driving, e.g., during a trip abroad, this can be arranged by removing fuse No. 4 (see page 57).

(The day running lights are used on cars marketed in Great Britain.)

P Parking lights. Day running lights switched off.

The parking lights should only be used when parking and **never when driving.**

D Headlights and parking lights. Day running lights switched off.

The headlights should naturally be on when driving in darkness or on poorly lit streets and roads.

A reminder buzzer sounds if the parking lights or headlights are on (or if the ignition key is still in the ignition switch steering wheel lock) and the driver's door is open.

Panel illumination knob

Clockwise: stronger panel light.
Anti-clockwise: weaker panel light.

Windscreen, headlamp, tailgate window wipe/wash

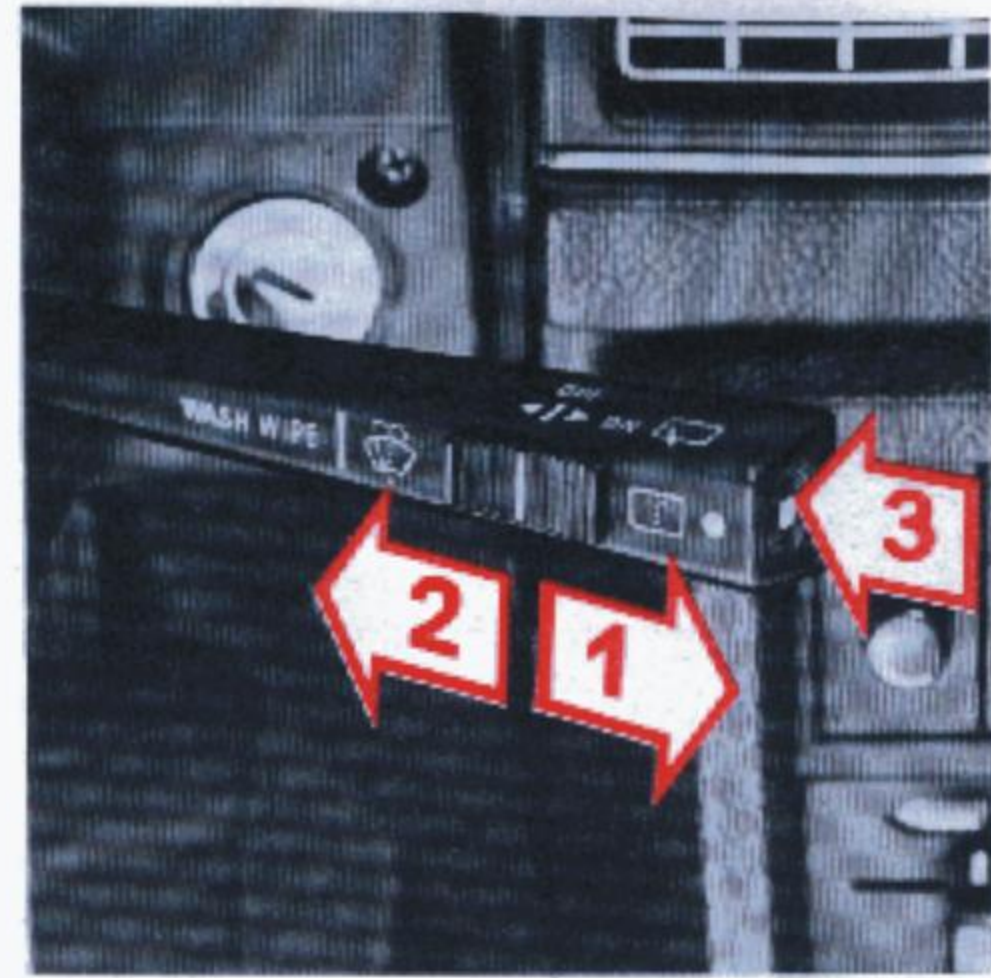
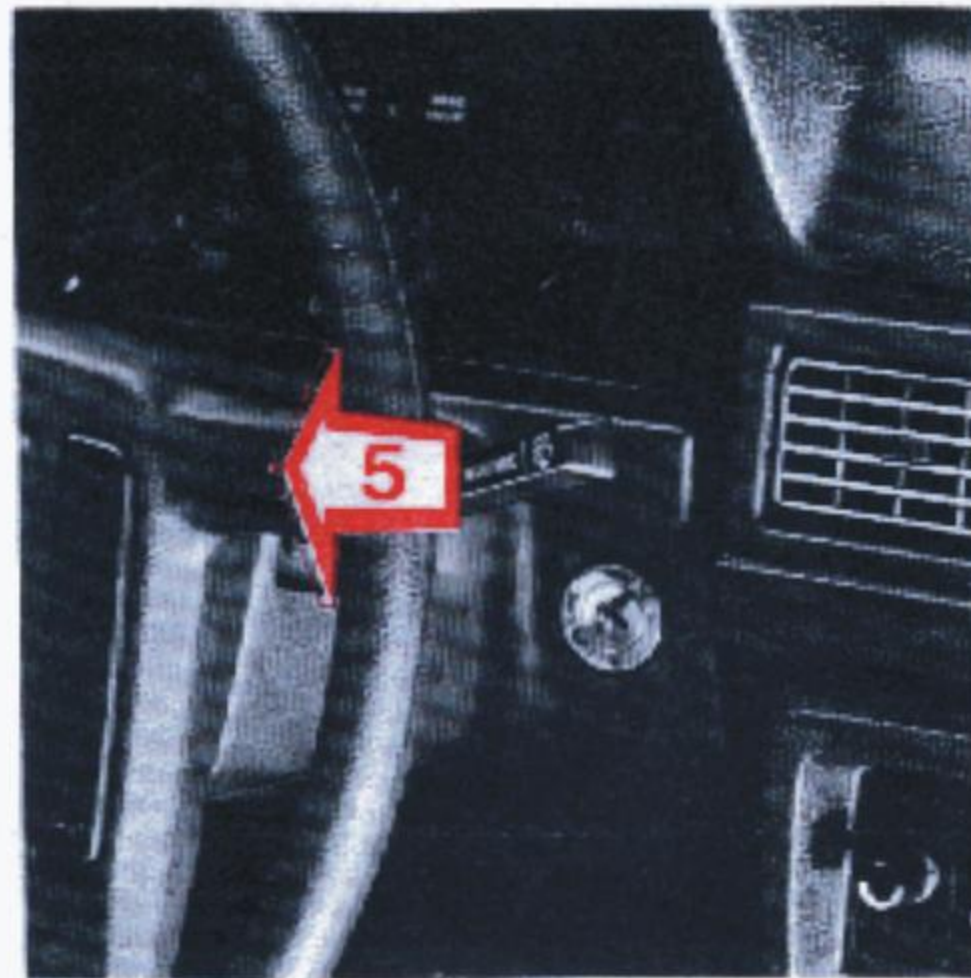
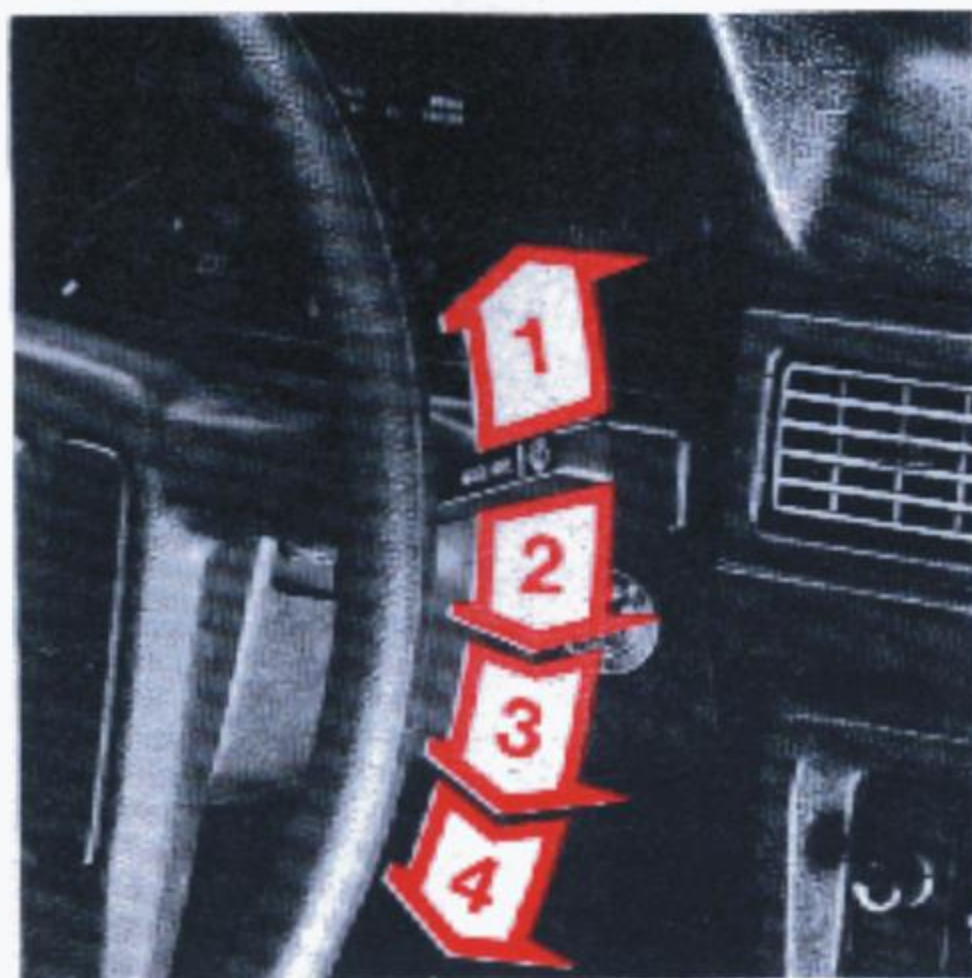

Windscreen wipe/wash, headlamp wipe/wash

1 Single-sweep position

If you move the wipe/wash stalk to this position the wipers will make a single sweep about every five seconds. Can suitably be used when driving in drizzling rain or in fog.

2 Wipe-pause position

If you want the wipers to make only one or two sweeps, move the stalk to this position and hold it there with your finger. When you let it go, the wipers return to their parking position.

3 Windscreen wipers — normal speed

4 Windscreen wipers — high speed

5 Windscreen wipe/wash + headlamp wipe/wash

The windscreen wipers make 2–3 double sweeps after you have released the stalk. Headlamp wipers only on cars intended for Gt. Britain.

Note! The headlamp wipers have an overload protection which disengages the wipers if snow or ice blocks the wiper blades. On such an occasion switch off the ignition and remove the snow or ice. Before operating the wipers again, wait a couple of minutes or so after switching on the ignition.

Tailgate wiper, washer 245

1 Tailgate wiper

2 Interval sweep position (only on 245 GLE)
With the button in this position, the tailgate wiper makes one sweep about every five seconds.

3 Tailgate washer

The wiper makes 2–3 double sweeps after the button has been released.

Rear fog lights, rear demist, hazard warning lights

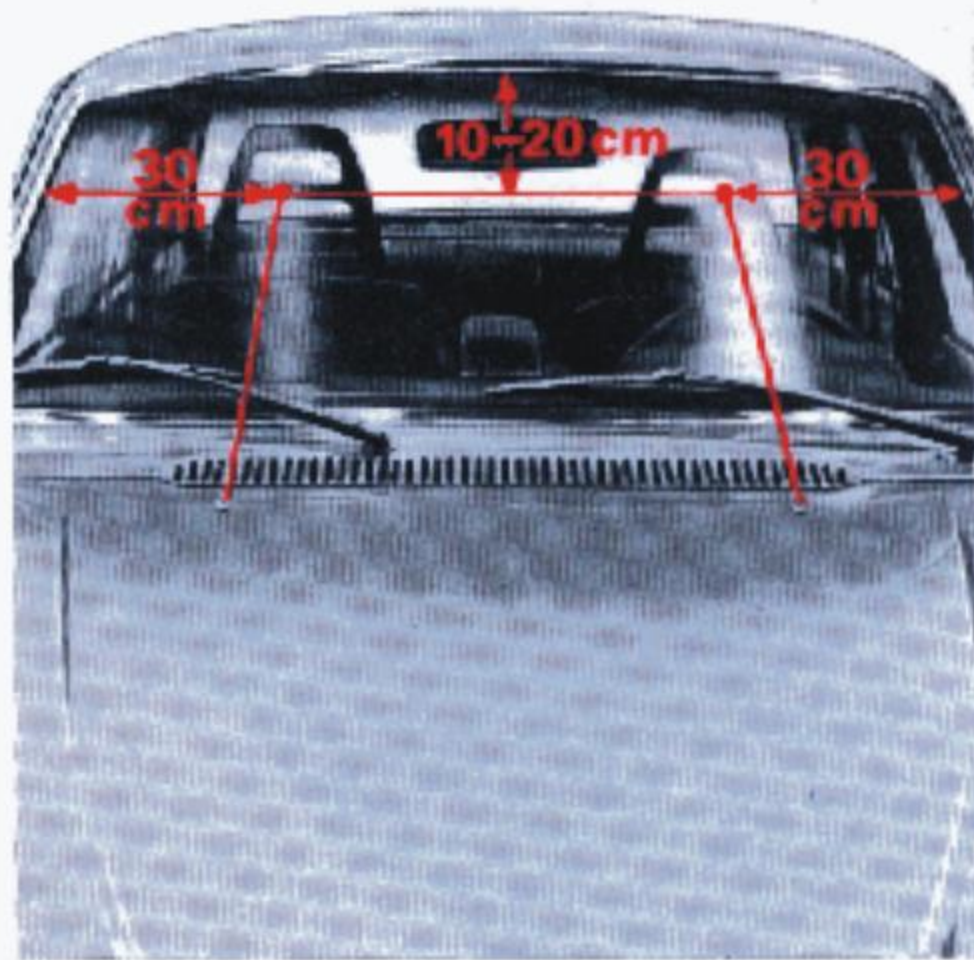

Rear fog lights

Rear demist

Hazard warning lights

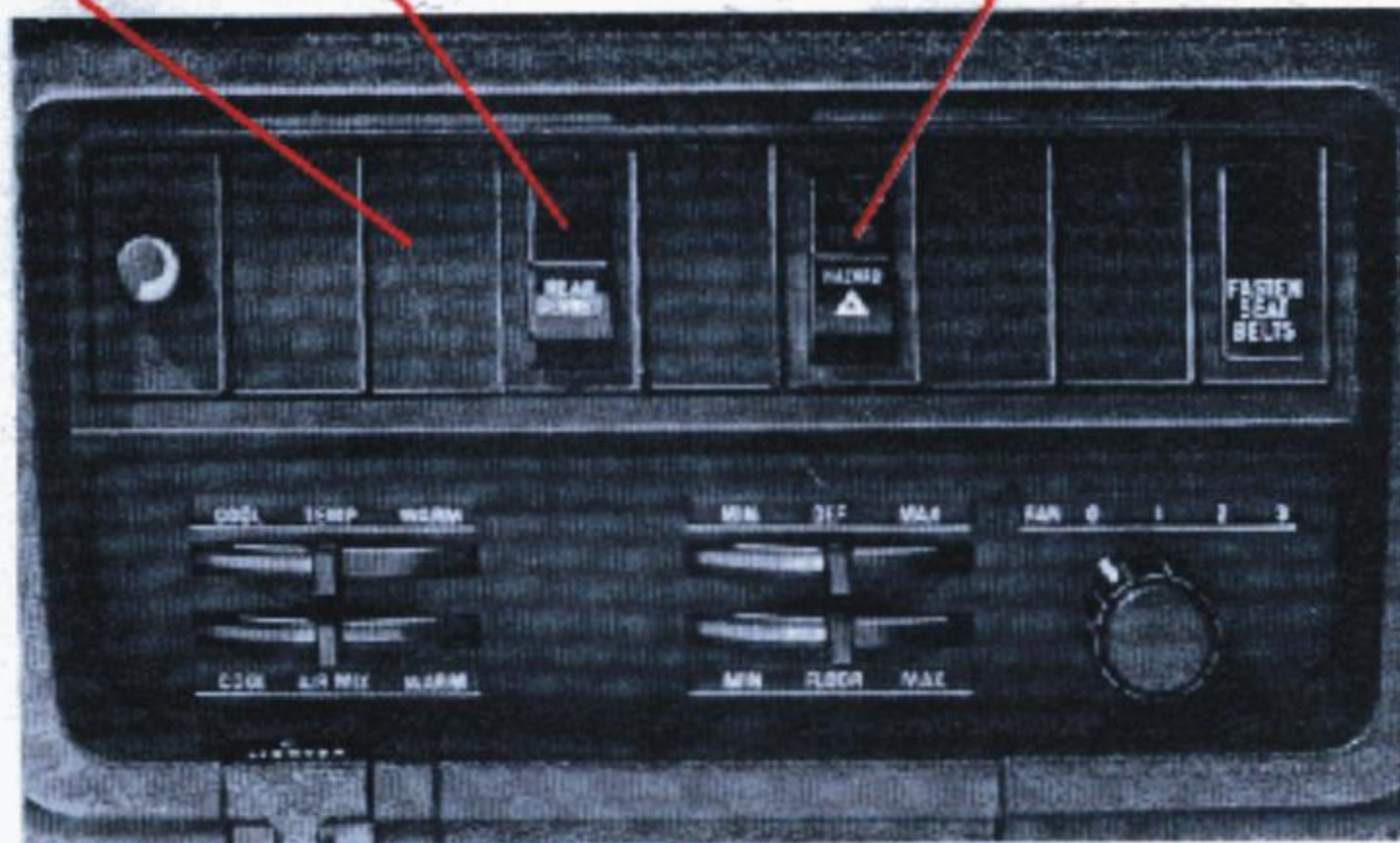

Adjusting the washer nozzles

Stick a pin in the nozzles and adjust their position so that the jets strike the window as shown in the picture.

Wash reservoir

The wash reservoir serves both the windscreen and headlamp washers. It is placed under the bonnet and holds about six (10 UKpints) litres. The reservoir for the tail gate wash on the 245 holds about 1.5 litres (2.5 UKpints) and is placed under the floor to the right in the cargo space (where the petrol tank filler pipe is located).

The reservoirs should be filled in the winter time with the anti-freeze specified on page 70.

Rear demist — heated rear window

Switch off once the rear window is free from mist and ice so as not to overload the battery unduly.

Avoid placing anything near the heating wires that could damage them. Observe due care when wiping the inside of the rear window since rings on fingers, etc., can damage the wires.

Hazard warning lights

Use the hazard warning lights only when you have to stop or park the car where it might be a possible danger to other traffic.

Note that regulations governing the use of these lights may vary in different places.

Rear fog lights (certain markets)

Use the lights when driving where there is fog or, e.g., rain or snow which considerably impairs vision.

Clock, cigar lighter, ashtrays

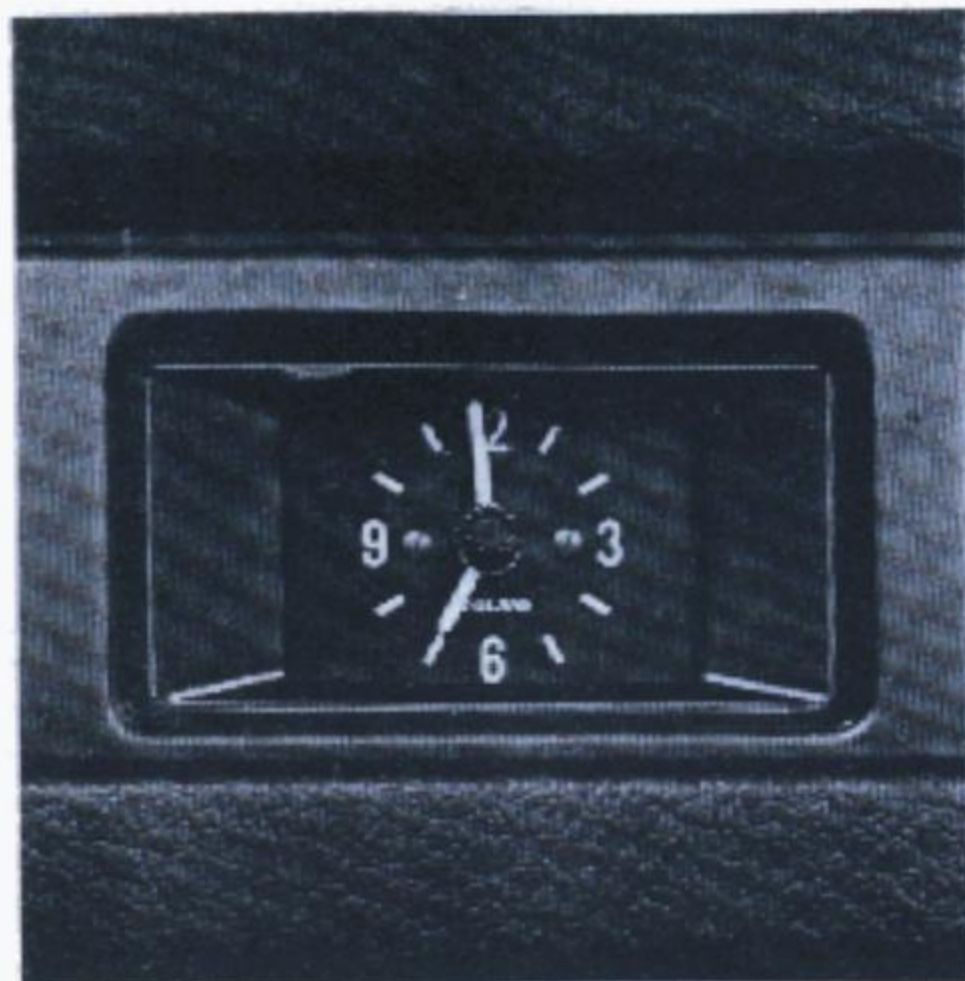

Clock

The clock is electrically operated from the car battery. To reset the hands, push in the knob in the middle and rotate it.

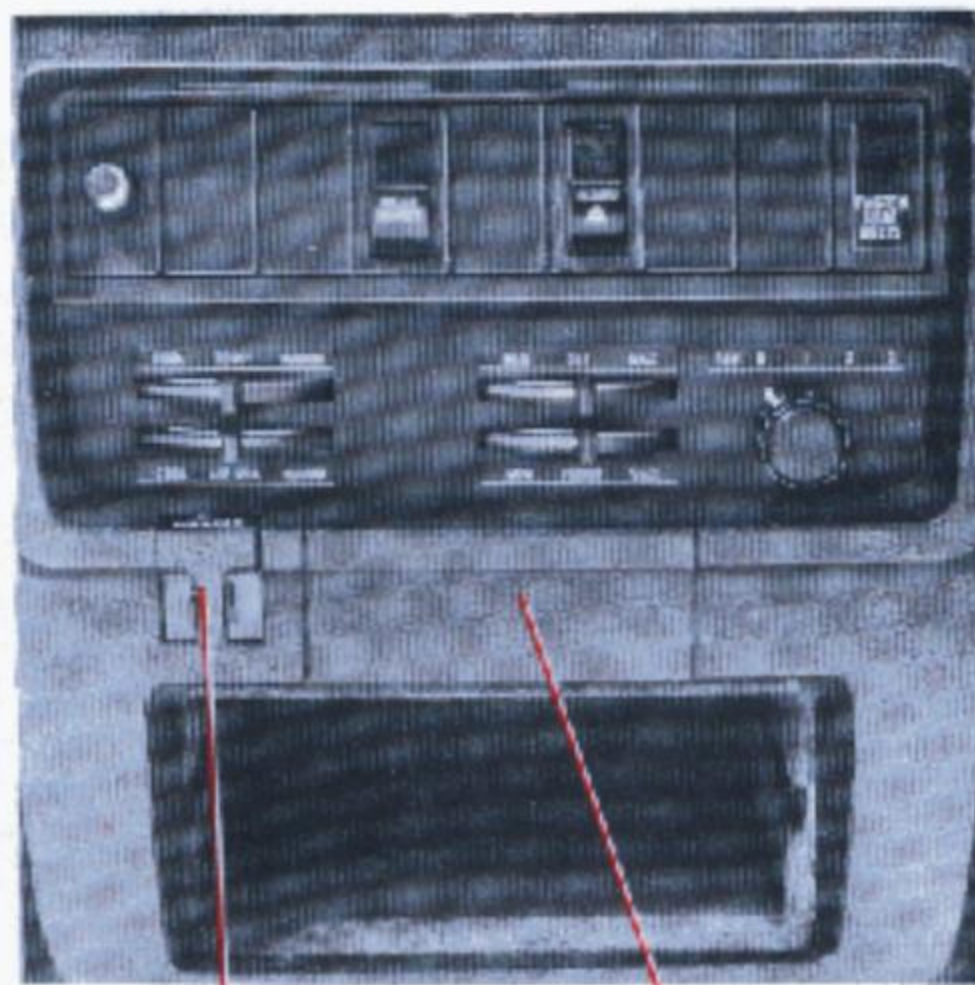

Cigar lighter

Ashtray

Cigar lighter and ashtrays

To use the cigar lighter, push it in fully. It springs back automatically when sufficiently heated.

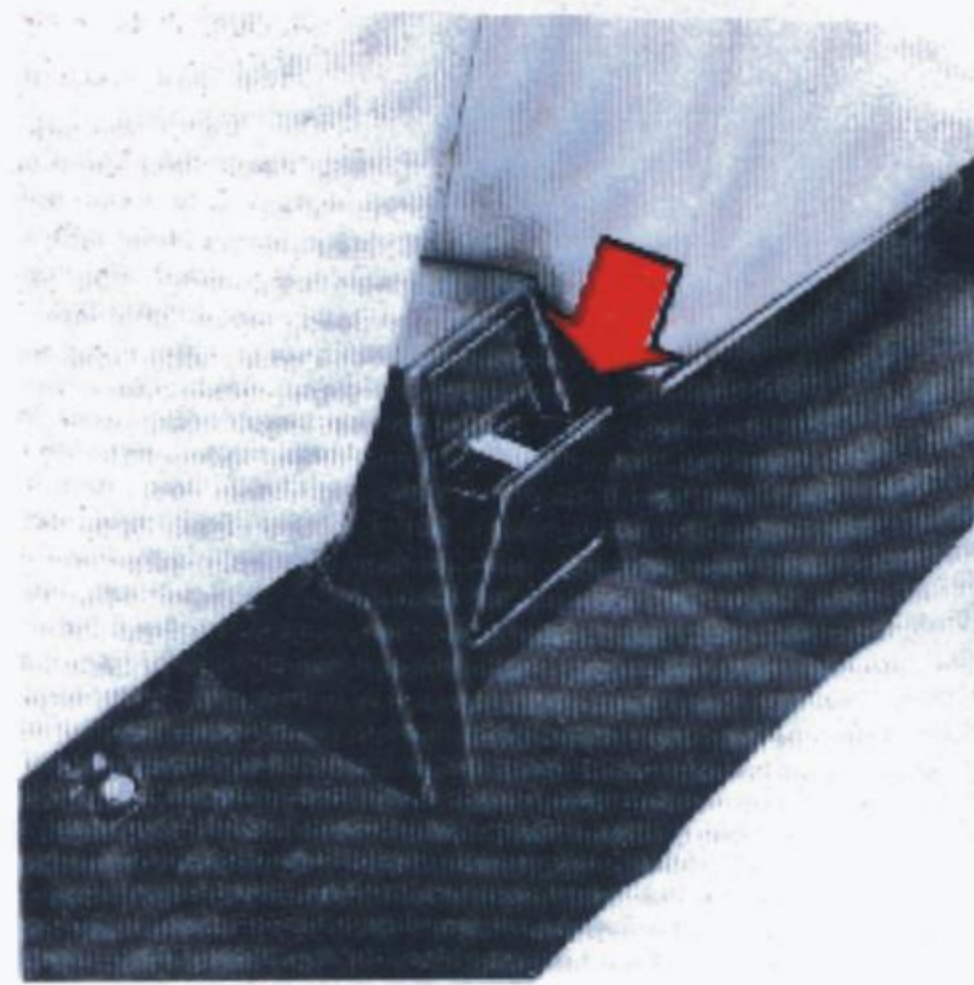

Ashtray for rear seat

To empty the ashtrays, draw them out fully, press down the tongue and remove.

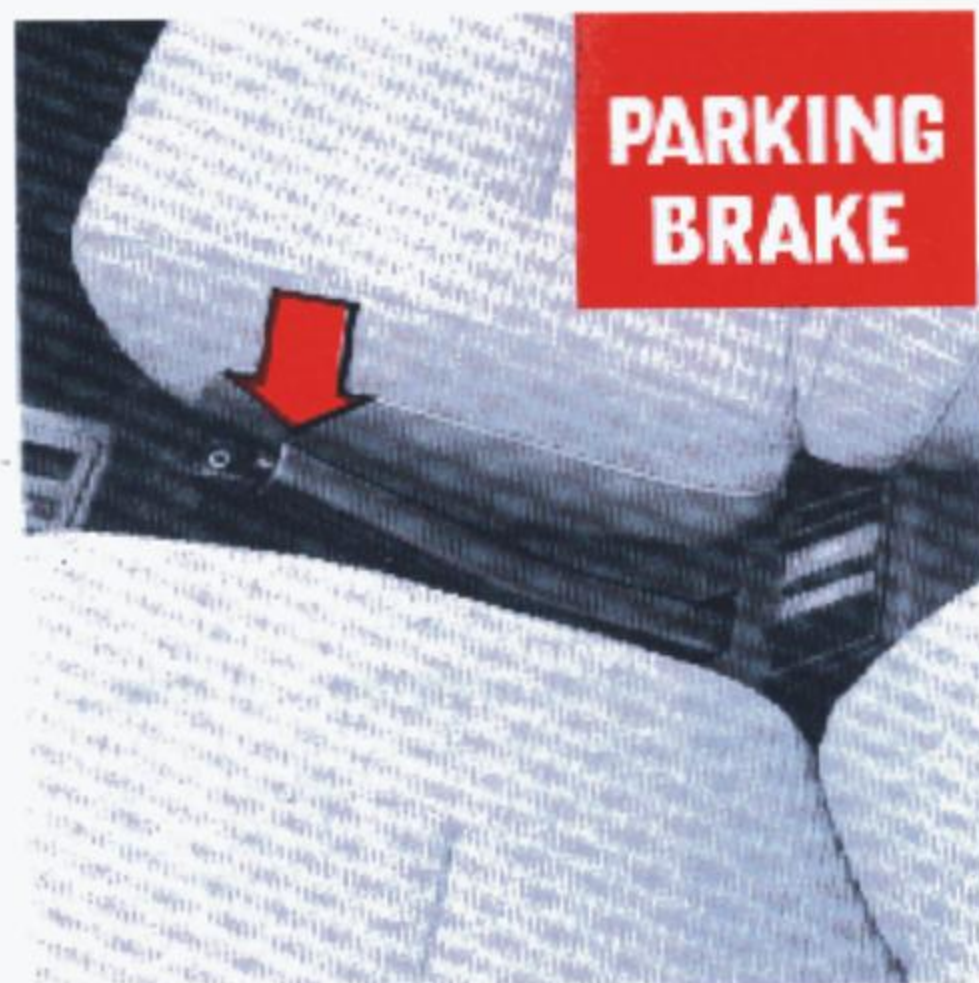

Parking brake indicator light

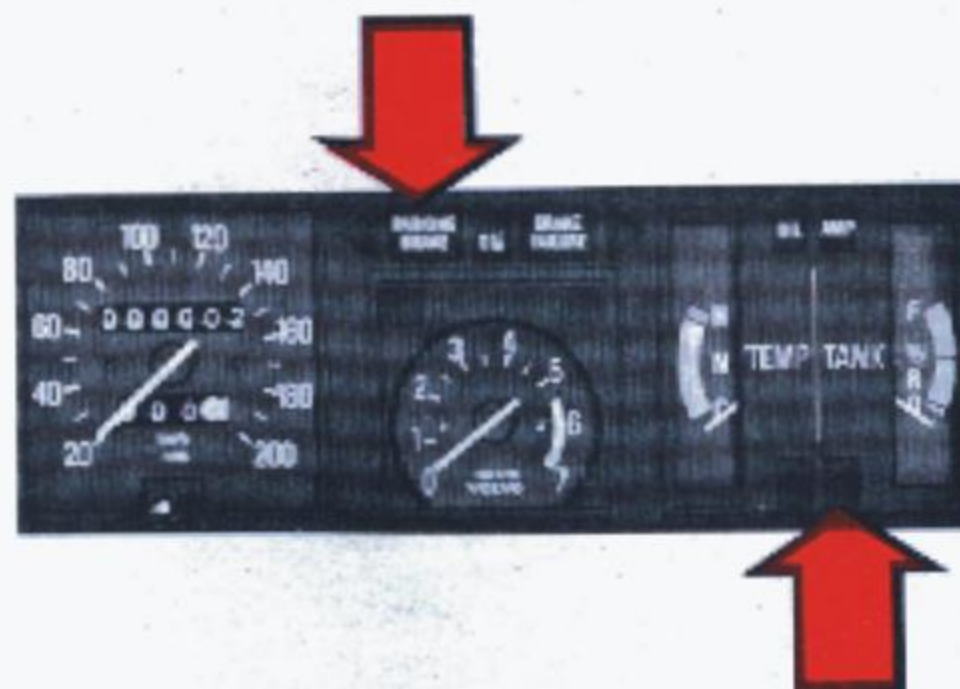

Choke indicator light

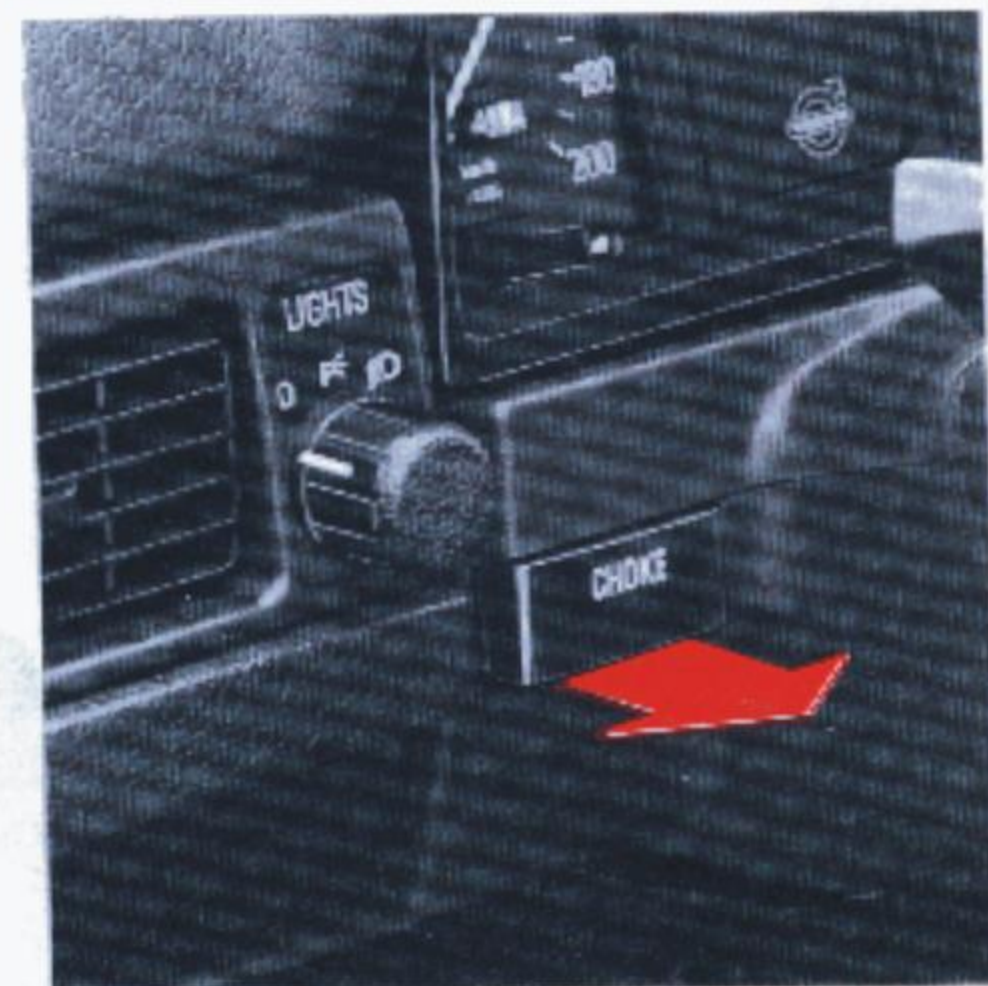

Parking brake (handbrake)

The parking brake is situated between the front seats. It operates on the rear wheels.

When the parking brake is applied, and the ignition switched on, the PARKING BRAKE light on the instrument panel goes on. We recommend the use of the parking brake at least a couple of times a week to make sure none of its components have jammed.

Choke (only in cars with carburettor engines)

Pull the choke out fully before starting a cold engine.

Pulling the choke out a fraction of an inch or so regulates engine idling to some extent. Choke light on the instrument panel goes on when the choke is pulled out.

Use the choke as briefly as possible!

See "Starting the engine", page 32.

Heating and ventilation

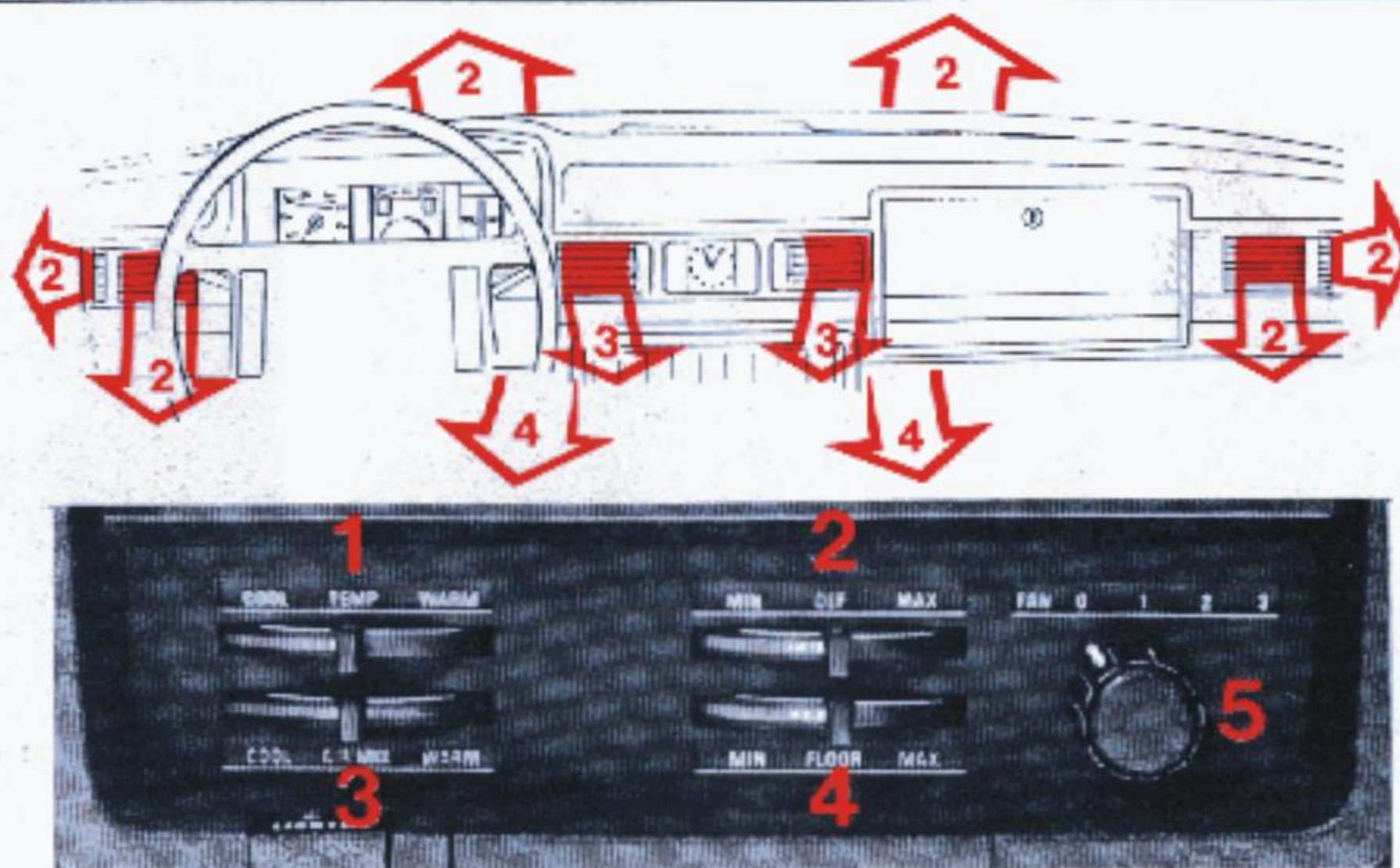

Standard heating system

1 TEMP

Left = COOL - *дніодуе*
 Right = WARM - *цёпліе*

2 DEF (defroster) *на шыбы*

Air to windscreen and the two outer vents.
 Left = MIN
 Right = MAX

3 AIR MIX

Air to the two centre vents.
 Left = COOL — fresh air
 Right = WARM — heated fresh air
 Cool and heated fresh air can be mixed to desired temperature, but not, however, warmer than that set by TEMP control lever.

4 FLOOR - *падола*

Left = MIN — no air to floor
 Right = MAX — full air flow to floor

5 FAN (Air blower)

0 = off
 3 = max.

To get best heating ...



Close the air vents on the fascia and the floor fresh-air vents.

... and to remove mist:



Also close the air vents on the fascia and the floor fresh-air vents. If it has been snowing, remove any snow over the air intake to the heating system.

... and to get best ventilation:



The floor fresh-air vents must be fully open and the fan speed reduced if you want particularly cool air.



Fresh-air vents

A fresh-air vent is situated on each side near the feet. Air flow is regulated by the lever in the middle of the vent.

Lever forwards – vent open
Lever rearwards – vent closed

Maximum flow is obtained with the vents fully open and the fresh-air fan closed. If the fan speed is increased, the fresh air will flow through the air vents on the fascia instead.

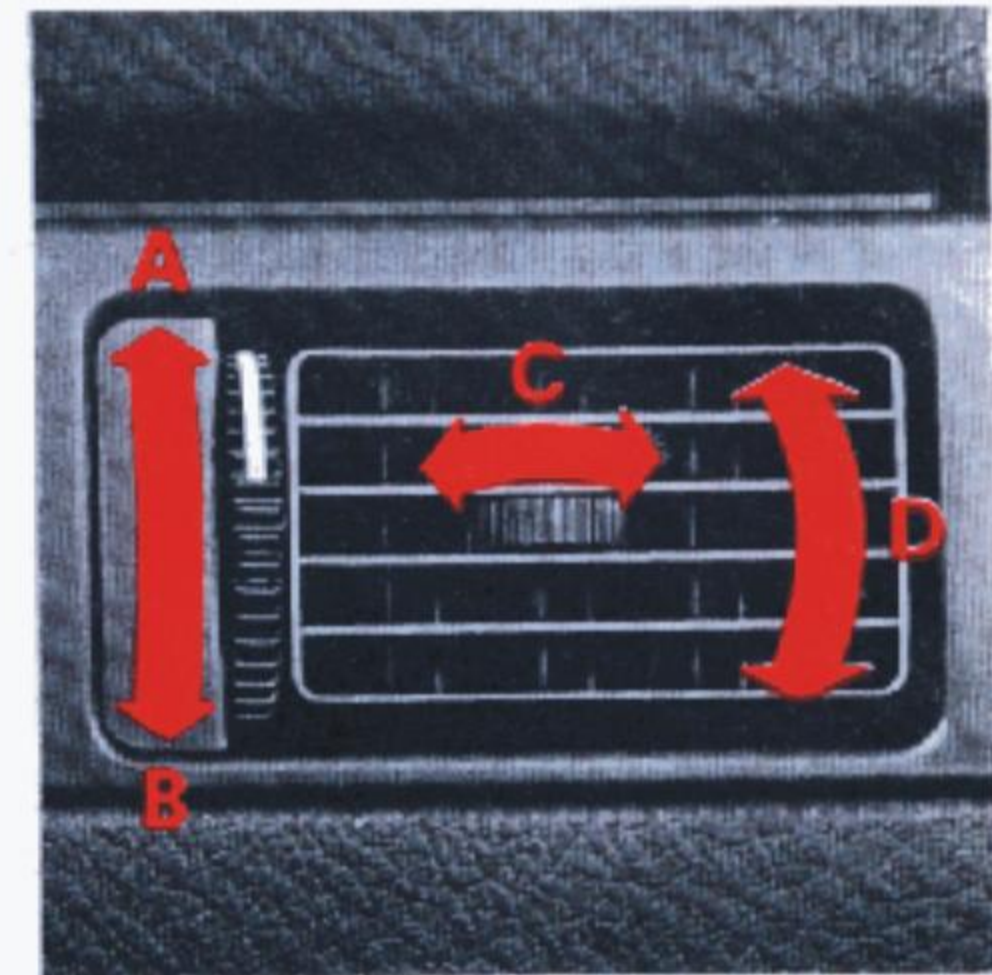

Air vents

A closed
B open
C air flow to the side
D air flow vertically

Note that the four air vents function differently. You can regulate the air flow through the two outer air vents with the defroster lever. The two centre air vents, on the other hand, can only be operated by means of the vertical serrated wheel next to them.

Heating and ventilation

Combined unit heating system (certain models)

This heating system is standard on all models on certain markets.

1 TEMP

Left = COOL

Right = WARM

2 FLOOR

Not pushed in = no air to floor

Pushed in = max. air to floor

3 DEF (defroster)

Not pushed in = weak defroster effect

Pushed in = max. defroster

4 REC (recirculation)

Intended only to be used if the car is fitted with air conditioning. Not to be used for heating.

5 FAN

0 = off

3 = max.

6 Air vents

Air flow through these vents is reduced if 2 FLOOR and 3 DEF are open.

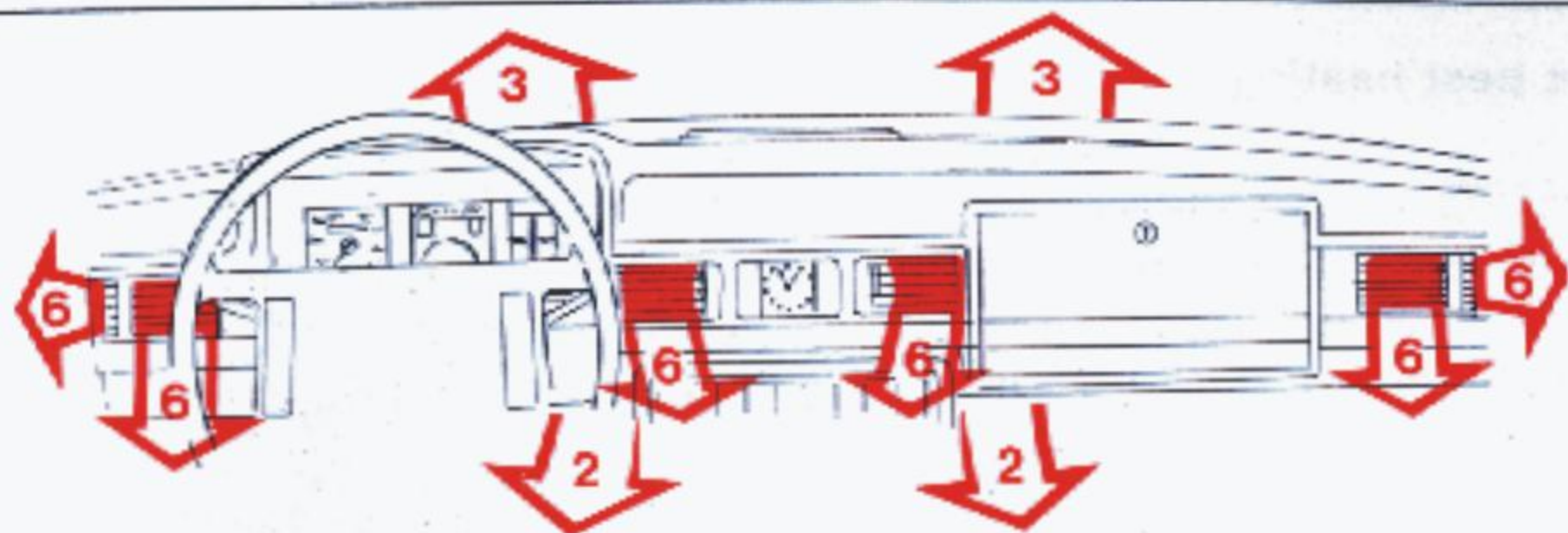

Proceed as follows to get best heating

- 1 TEMP → WARM
 - 2 FLOOR button pushed in
 - 5 FAN → 2 (possibly 3)
 - 6 All air vents closed
- Also close floor fresh-air vents.

... and remove mist

- 1 TEMP → WARM
- 3 DEF button pushed in
- 5 FAN → 3
- 6 All air vents closed

Also close floor fresh-air vents.
If snow has fallen, remove any snow on the air intake (in front of the windscreen).



Air conditioning (optional equipment)

Air conditioning is standard on certain markets.

1 FAN

Switch to 3 for rapid cooling.
The fan should always be engaged when air conditioning is used.

2 AIR COND (compressor)

Push in the button to start the compressor.

3 REC (recirculation)

Should be pushed in when cooling the compartment and if outside temperature and/or humidity are high.

4 TEMP

Switch to COOL for rapid cooling. Then adjust to suitable temperature as required.

Also remember the following:

The windows and the floor vents must be closed. FLOOR and DEF should **not** be pushed in.

All air now comes in through the air vents on the facia.

The air vents should be open.

Worth remembering: You can use the air conditioning for rapid removal of mist inside the car even when it is relatively cold outside. Moisture in the compartment will then rapidly disappear since the air conditioning de-moistens the air before it is blown into the compartment.

Let a Volvo workshop check the air conditioning every year.

Rear view mirrors

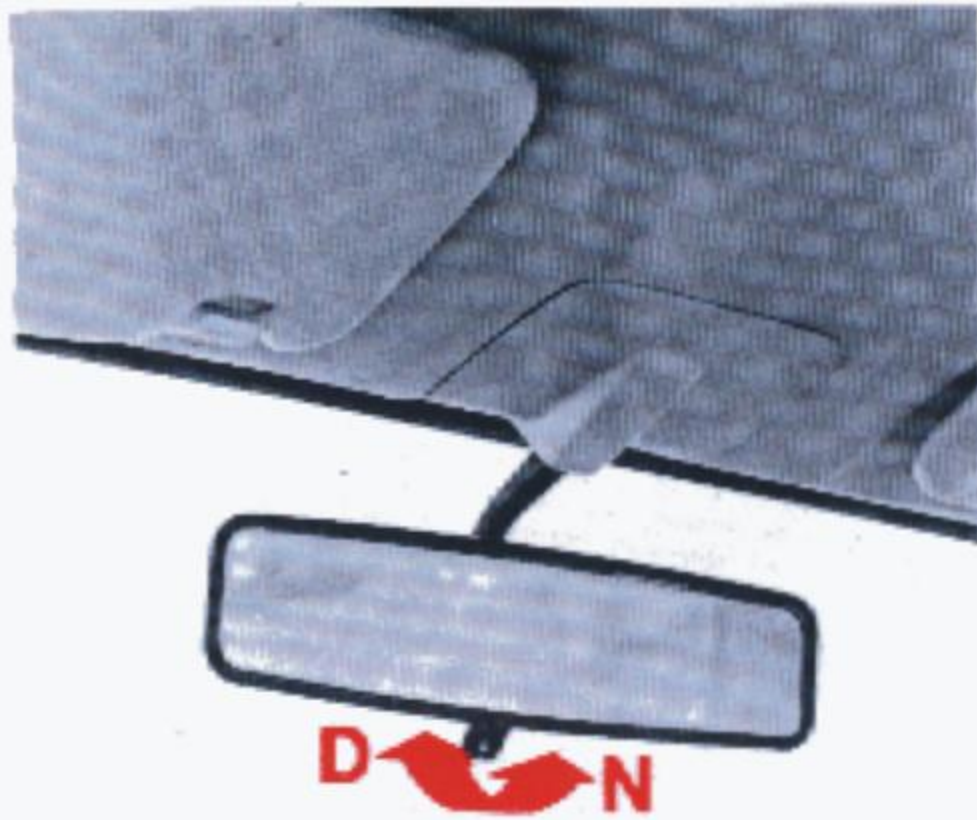

Inside rear view mirror

D Normal position

N Anti-dazzle position — use if headlights of car behind irritate you.

Outside rear view mirrors (certain markets)

A Lateral adjustment

B Vertical adjustment

Always adjust the mirrors before driving off!

Hinged rear quarter-light, courtesy light, sun roof

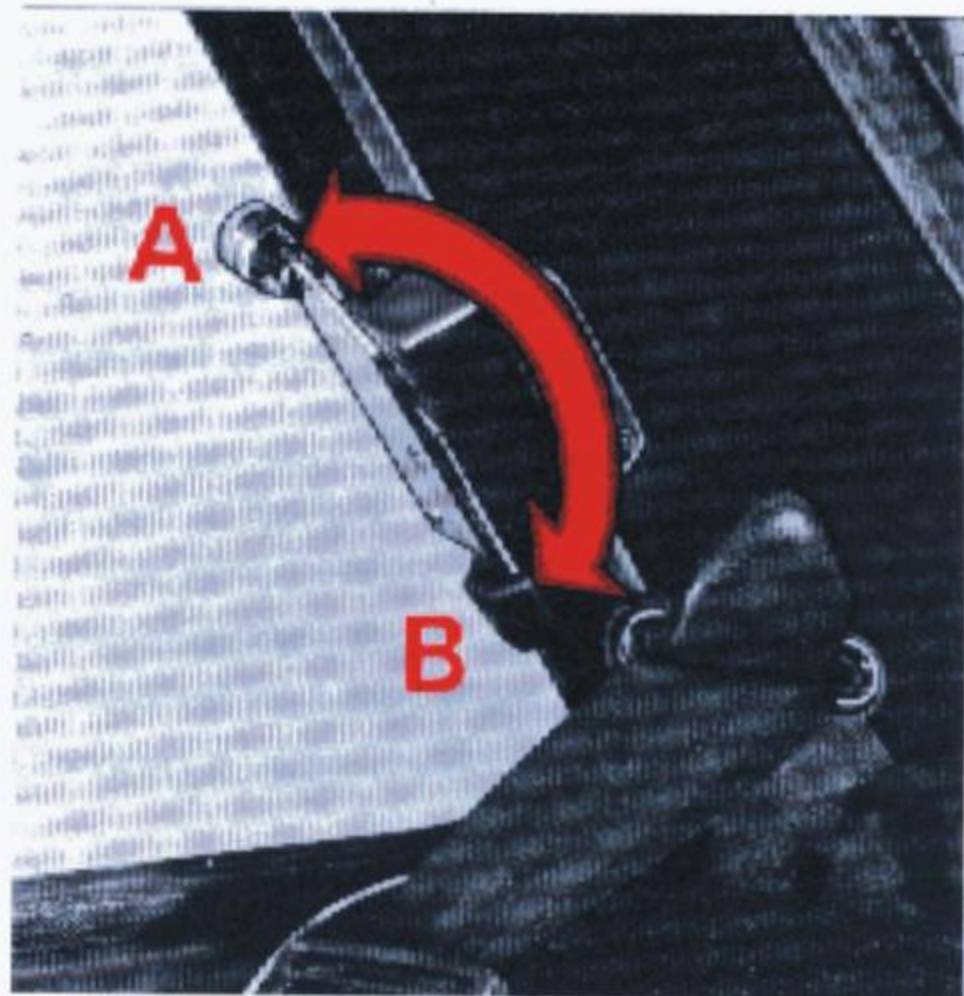

Hinged rear quarter-light (2-door cars)

- A Open
- B Closed

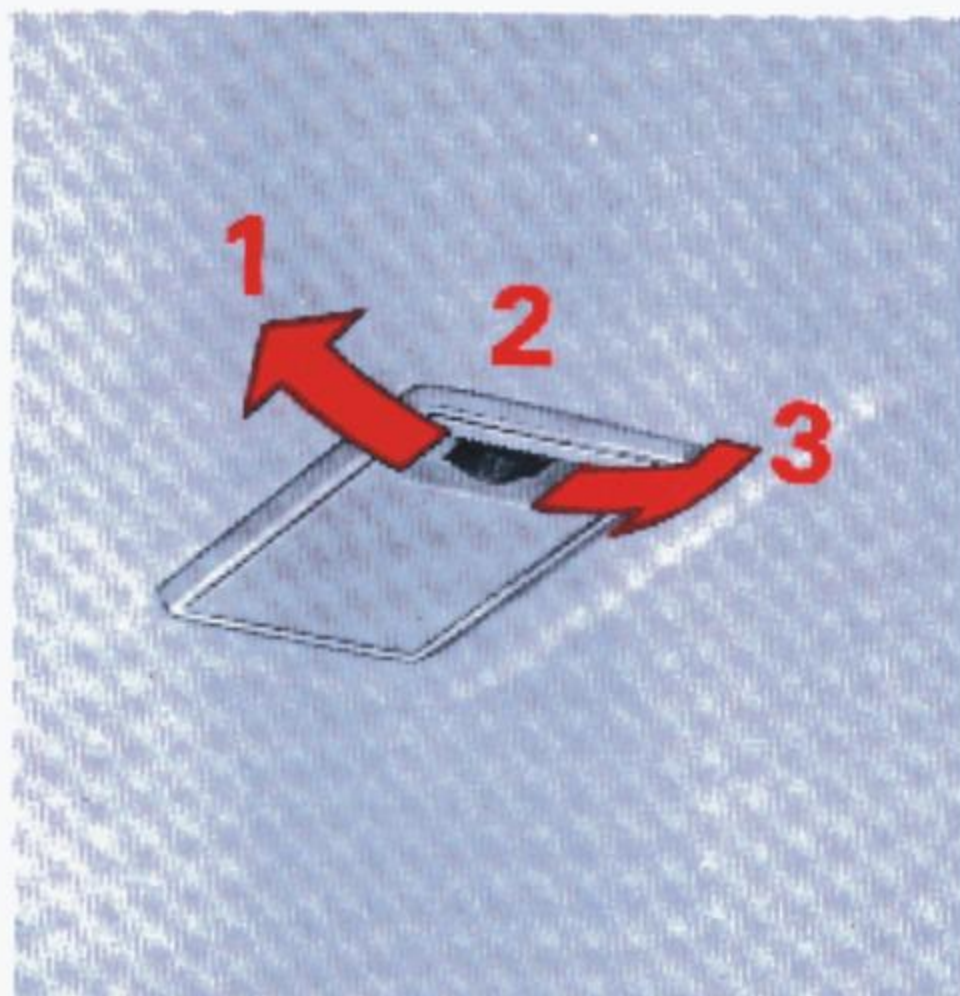

Courtesy light

- 1 The light is always on.
- 2 The light is always out.
- 3 The light goes on when one of the doors is opened.

The 245 has a somewhat different type of bulb housing for its courtesy lights.

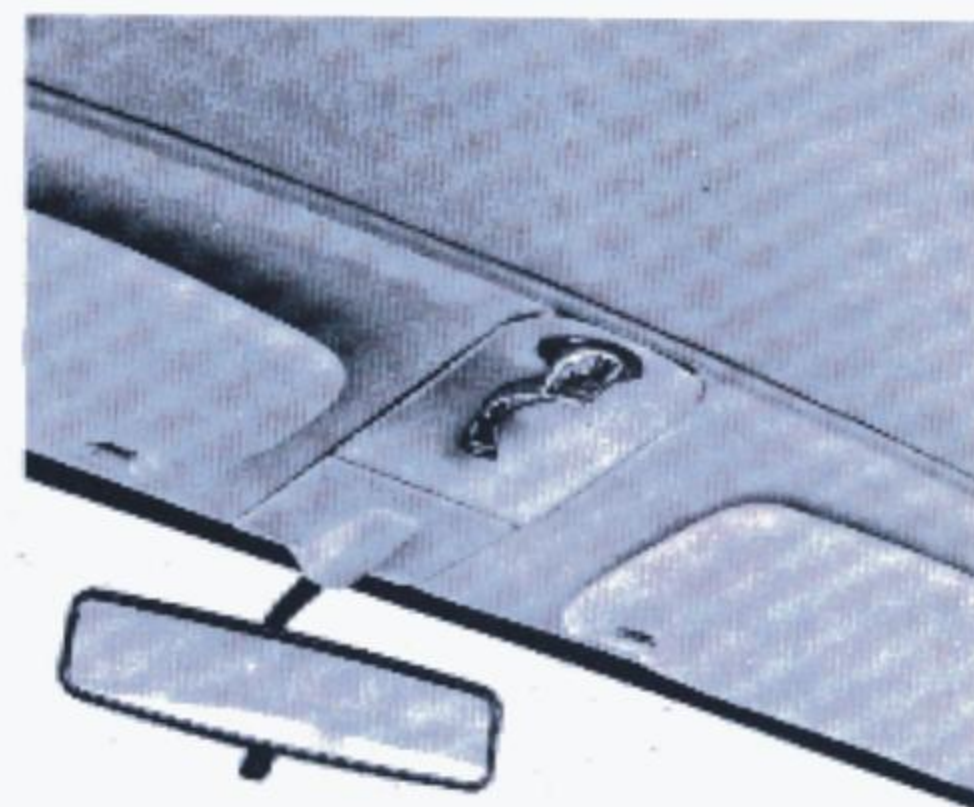

Sun roof (certain models)

The sun roof is opened and closed by a winding handle situated between the sun visors. Open out the handle and crank anti-clockwise to open the sun roof, and clockwise to close it. **For reasons of safety, the handle should always be in its recess during driving.**

Front seats

Adjusting the height position

The height of the driver's seat can be adjusted front and rear to three different positions by means of the respective levers there.

The angle of the seating cushions can also be altered to different positions.

Make sure that the seat is properly secured after adjusting.

Never adjust when driving!

The passenger seat is bolted to four brackets on the floor. Any height adjustment of this seat will thus require the use of a tool.

Otherwise, the passenger seat has the same adjustment possibilities as the driver's seat. In other words, three different positions front and rear.

Adjusting lengthwise

To adjust the seat lengthwise, pull up the bar and move the seat forwards or backwards as desired. Make sure that the seat is properly secured when you release the bar.

Never adjust during driving!

For particularly long legged people, it is also possible to move the entire seat frame rearwards about 3 cm. Tools are required, however, to do this.

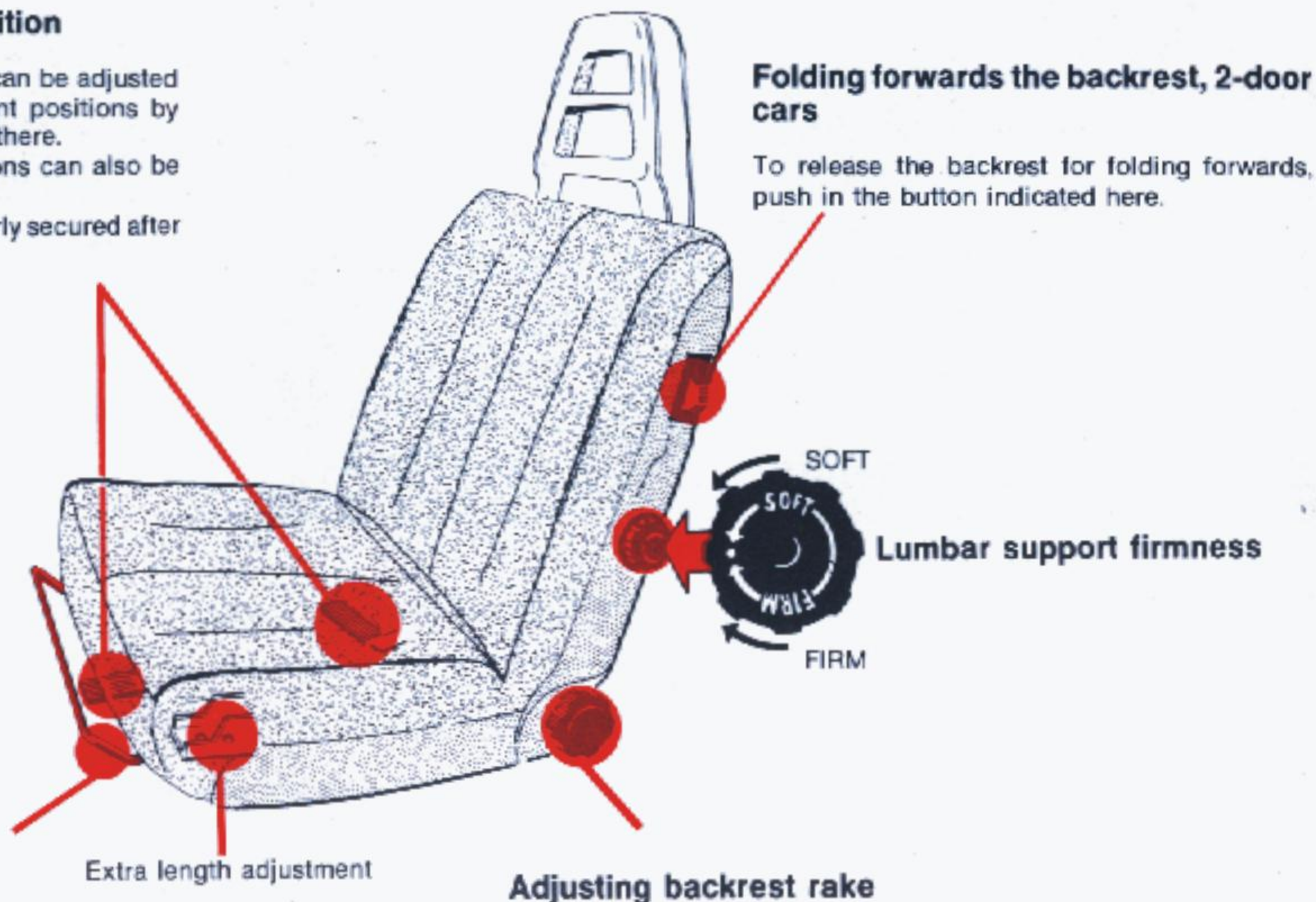

The front seat is electrically wired for heating on certain markets. At a temperature of about + 15° C (60° F) a thermostat switches on the heating, and switches it off when the temperature is about + 25° C (77° F).

Children in car

A grown-up with fastened seat belt in a Volvo is assured of good protection in the event of a collision or other accident.

The size and build of a child will determine how best it can be protected from injury when travelling in the car. The following, therefore, should be noted.

Remember that a child, irrespective of its age and size, must never be "loose" in the car. On no account should small children be seated on the lap of a person not using a seat belt.

Many countries have legislation as to where and how children should be seated in a car. Find out that which applies in your country.

Children can be divided into three different "size-build" groups.

Babies and small children who cannot sit up

Children belonging to this group should lie in a carry cot, detachable pram top or similar which is placed in the rear seat with the head of the baby towards the middle of the car. It can be prevented from falling down onto the floor in the event of abrupt braking, etc., either by fastening the rear seat belt round it or by installing the Volvo safety bench in front of the rear seat. This bench can be purchased from a Volvo dealer.

Children from the age they can sit and up to a size of about 117 cm = almost 4 ft. (up to 6-7 years).

Never use the kind of child's seat which is suspended from the backrest of the rear seat.

Use the Volvo child seat (available from your Volvo dealer). This seat is fixed "back-to-front" either on the front passenger seat or on the rear seat. In both cases, fasten the front passenger seat belt round the seat,

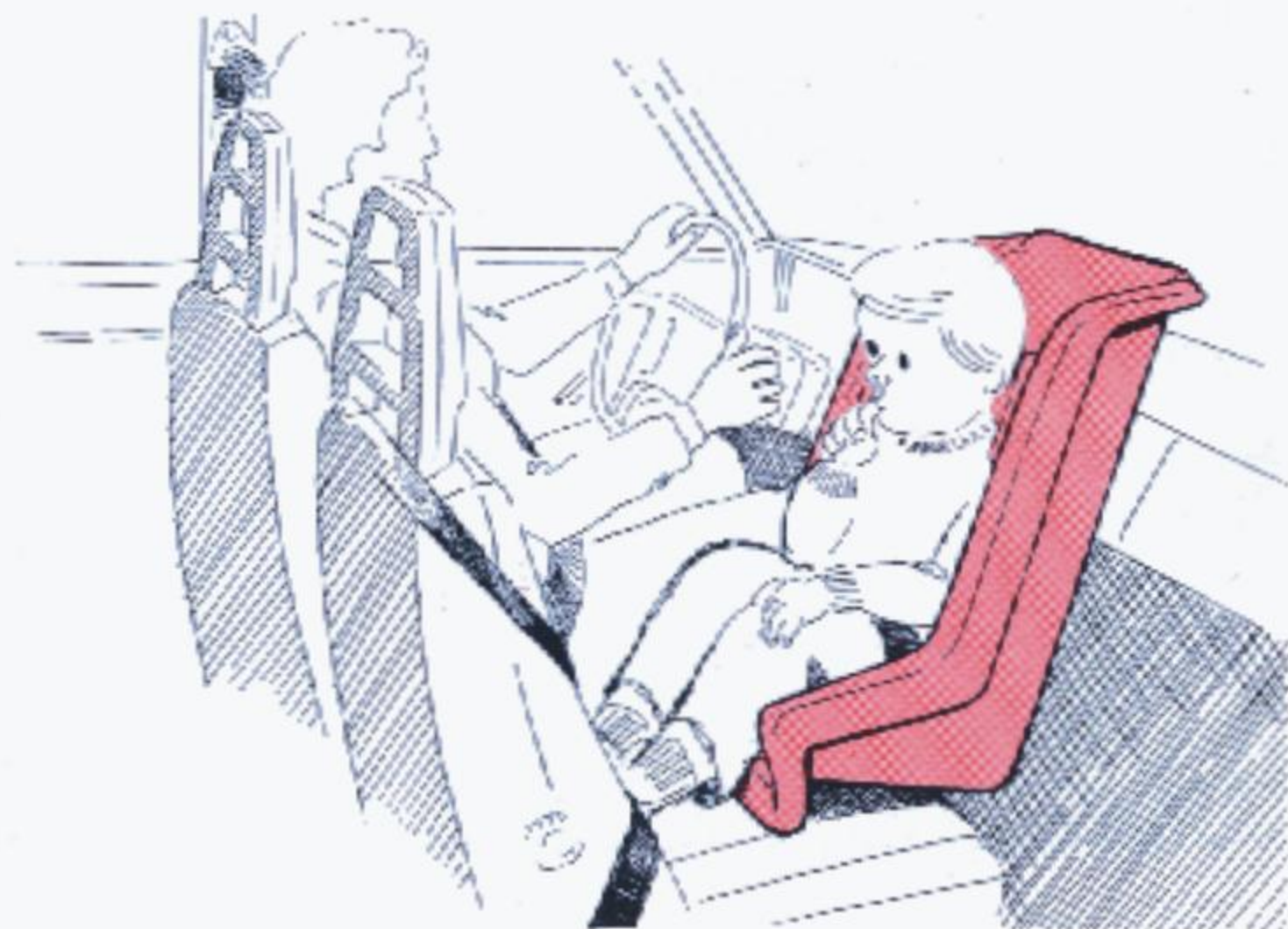

even if no one is sitting in it, in order to prevent it from coming loose in the event of a powerful collision. The installation instructions supplied with the seat will tell you how to fix it in position.

Children taller than 117 cm = almost 4 ft. (from the age of 6-7 years).

When a child has outgrown the child's seat, it should travel in the rear seat with the standard rear seat belt fastened.

The best seating arrangement for such a child from a safety point of view is to seat it on a cushion (your Volvo dealer may have the "special Volvo cushion") to enable the seat lap belt to fit as far down on the hips as possible.

The use of the seat belts is described in greater detail overleaf.

Seat belts



Seat belts

Always have the seat belts fastened for all types of driving. Even the rear seat passengers should naturally use the seat belts otherwise they can be thrown against the front seats in the event of a collision. Should this happen, the belt of the front seat concerned will be exposed to a much heavier load than it is intended for so that both persons can incur injury as a result. Even abrupt braking can give rise to serious consequences if the belts are not used.

Two warning lights, one on the instrument panel and one on the console for the parking brake start blinking if the driver or front-seat passenger has not fastened their seat belts.



Button for releasing belt

Automatically retracting inertia-reel seat belts

The front seats and the two ends (certain markets) of the rear passenger seat are fitted with automatically retracting inertia-reel seat belts.

These are fastened as follows: pull out the strap slowly to prevent the mechanism from locking. Push the tongue down into the lock. A pronounced click indicates that it is locked. **The belt must not be twisted.**



Button for releasing belt

To release the belt, push in the red button on the lock. Allow the belt to roll up fully.

Normally the belt is "unlocked". It locks, and thus cannot be drawn out:

- if pulled out rapidly
- when braking and accelerating
- if the car is at a fairly sharp angle
- when rounding a bend



Manually adjusted seat belts (certain markets)

The centre belt in the rear seat is of the lap type. It must always be adjusted to the correct length.

Lengthening: turn the adjuster/locking tongue and pull out the belt as shown in the picture.

Shortening: pull in the upper strap.

WARNING!

If the belt is exposed to tremendous strain, e.g., in connection with a collision, both belt and locking mechanism must be replaced, even if only apparently damaged, since the belt may have lost its safety effectiveness. The belt should also be replaced if one of the straps is damaged or worn.

Do not try to modify or repair a belt on your own. Let a Volvo workshop do it.

Checking the seat belts

Check that the belt has not jammed or frays against sharp edges. Also check now and again that the belt anchorage bolts are well-tightened and that the belt is otherwise in good condition.

Use water and a good quality detergent for cleaning the belt.

The locking function of the retracting inertia-reel seat belt can be checked as follows:

- Fasten the belt and quickly lurch forwards.
- Brake the car abruptly at about 50 km/h (30 mile/h) or drive round in a narrow circle. (But make sure this does not disturb traffic.) Tug the belt.

It should not be possible to pull out the belt during any of the above tests.

Doors and locks

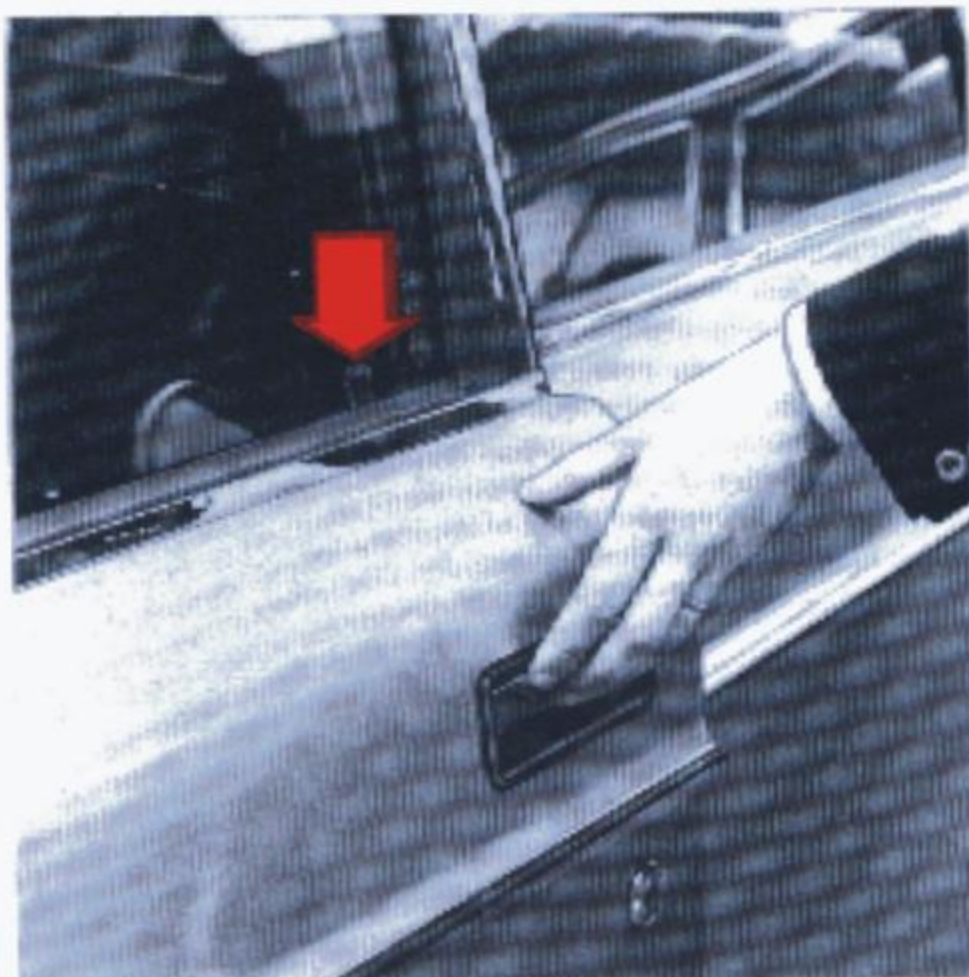
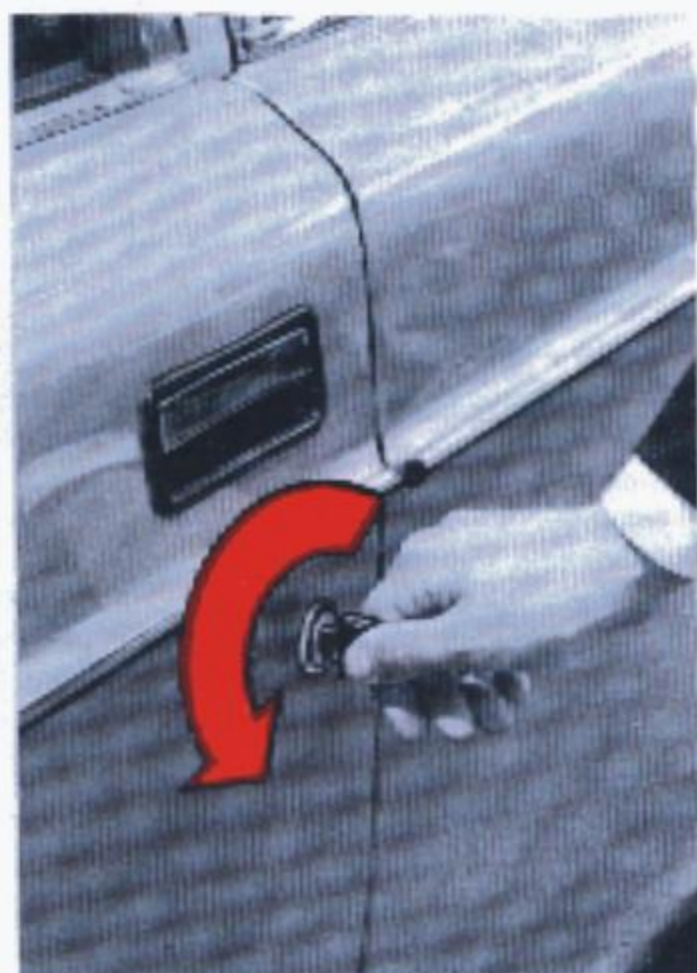

Unlocking the front doors

Both front doors are unlocked with the key supplied. To unlock and open the door, turn the key 1/4 turn anti-clockwise (clockwise, on r-h door). This pushes up the lock button on the inside so that the door can be opened with the door handle.

To open a door from the inside, the lock button must first be pulled up.

Locking the doors

The doors are locked by pushing down the lock button and shutting the door.

Do not leave the key in the car!

The front doors can also be locked from the outside with the key. Turn the key 1/4 turn clockwise (anti-clockwise for the right-hand door).

WARNING!

The doors should not be locked when driving, since this would prevent anyone from getting into the car quickly in the event of an accident.

The locks should be oiled with a suitable lock oil during the wintertime to protect against freezing.

If a lock has frozen, do not try to force it with a key otherwise the key may break in the lock. Instead, heat the lock or the key.

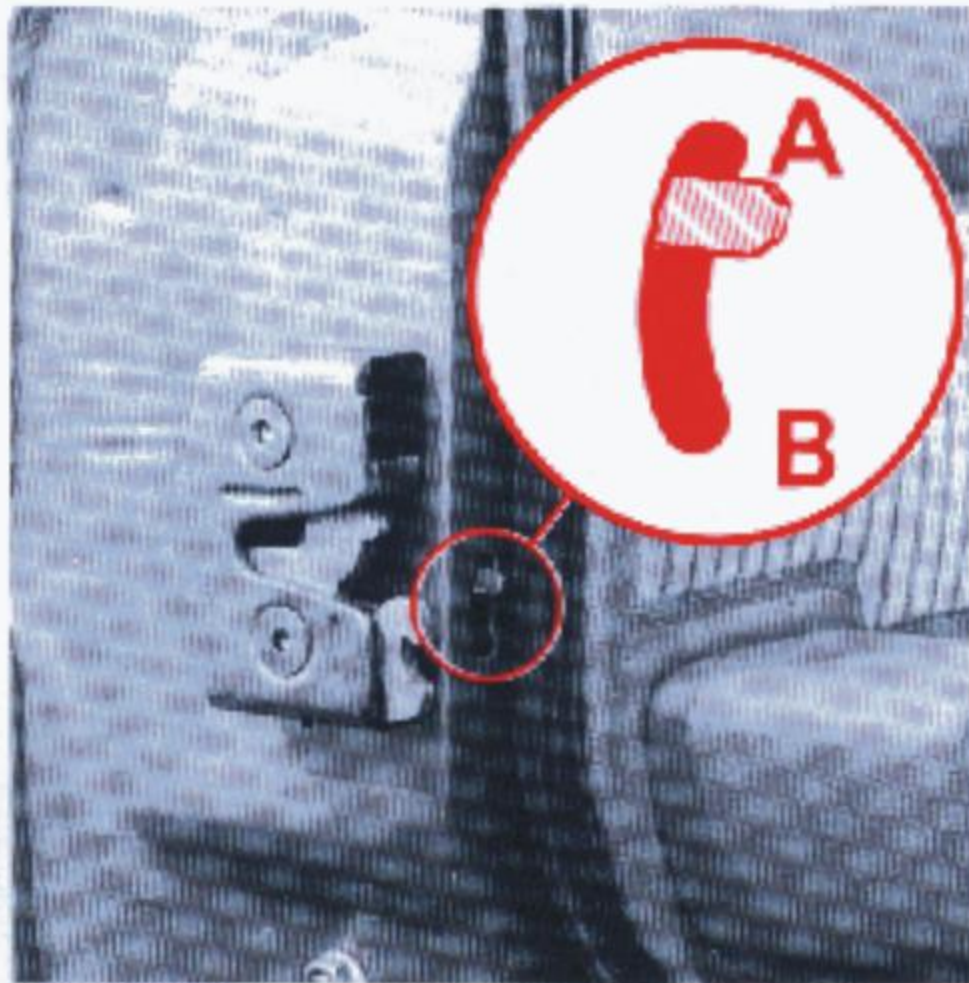

Child safety lock, 244 and 245

The small button for operating the child safety lock is situated on the inside at the end of the rear doors, and is accessible only when the door opens.

A the lock functions normally

B the door **cannot** be opened from the **inside**.

Remember that with the button in position B, the rear-seat passengers cannot get out through this rear door from the inside in event of an accident because it can only be opened from the outside.



Boot lid 242, 244

The lid is opened by turning the key clockwise. Spare wheel, warning triangle (certain markets), jack and tool kit are strapped in the boot to the left.

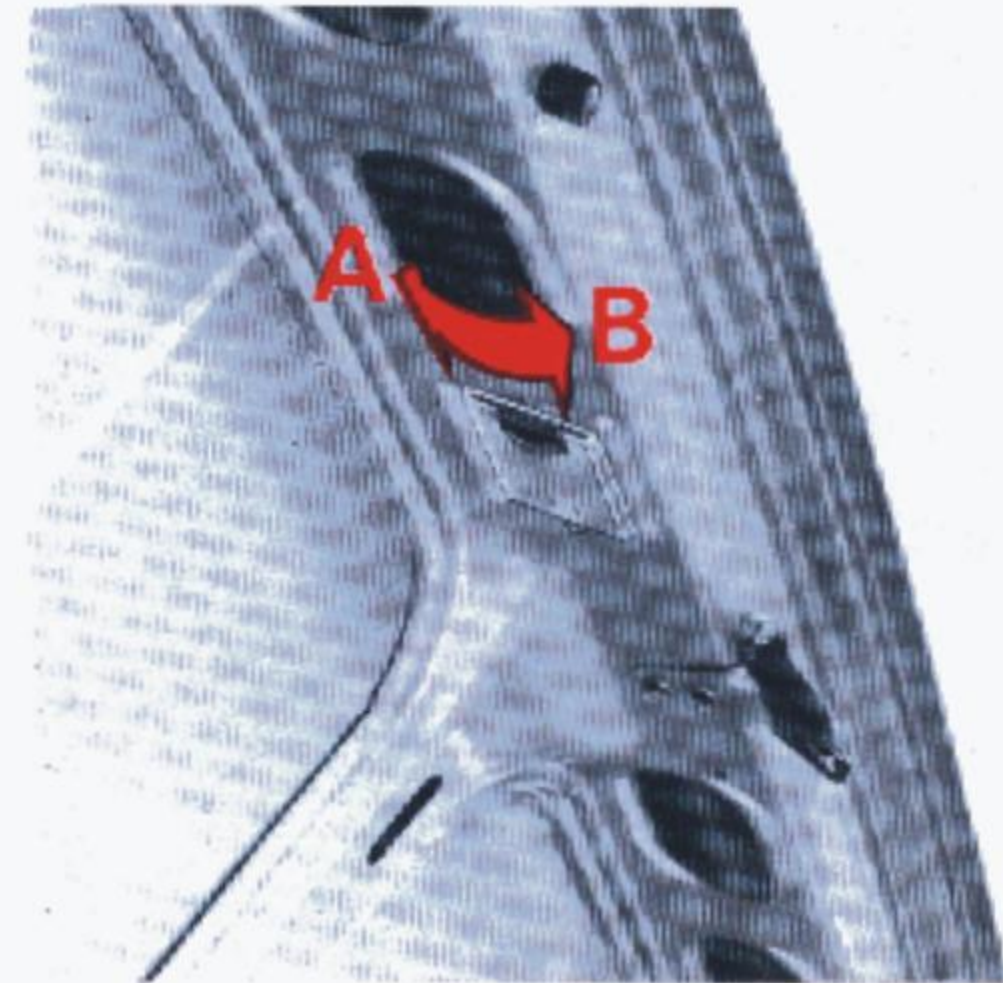

Boot light

A light always out

B light goes on when lid opens.

Bonnet, tank filler cap

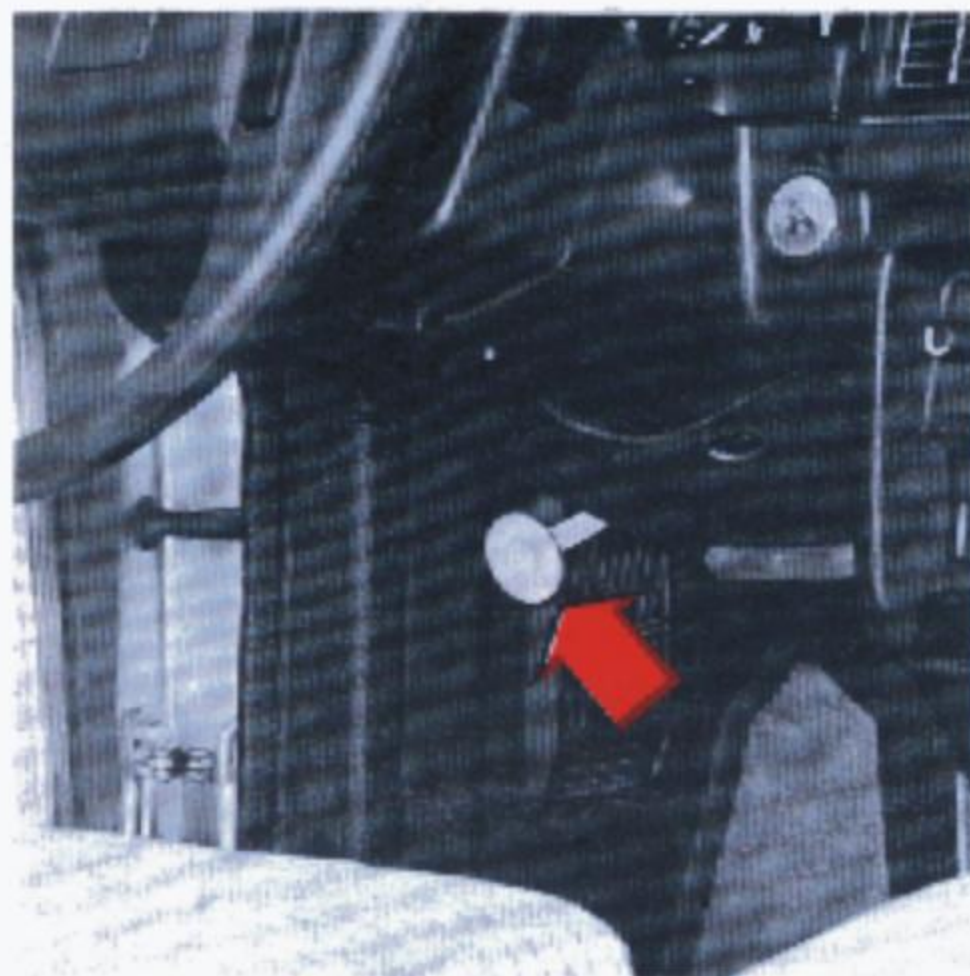

The bonnet is opened as follows

Pull the bonnet release knob (to the extreme left under the fascia).

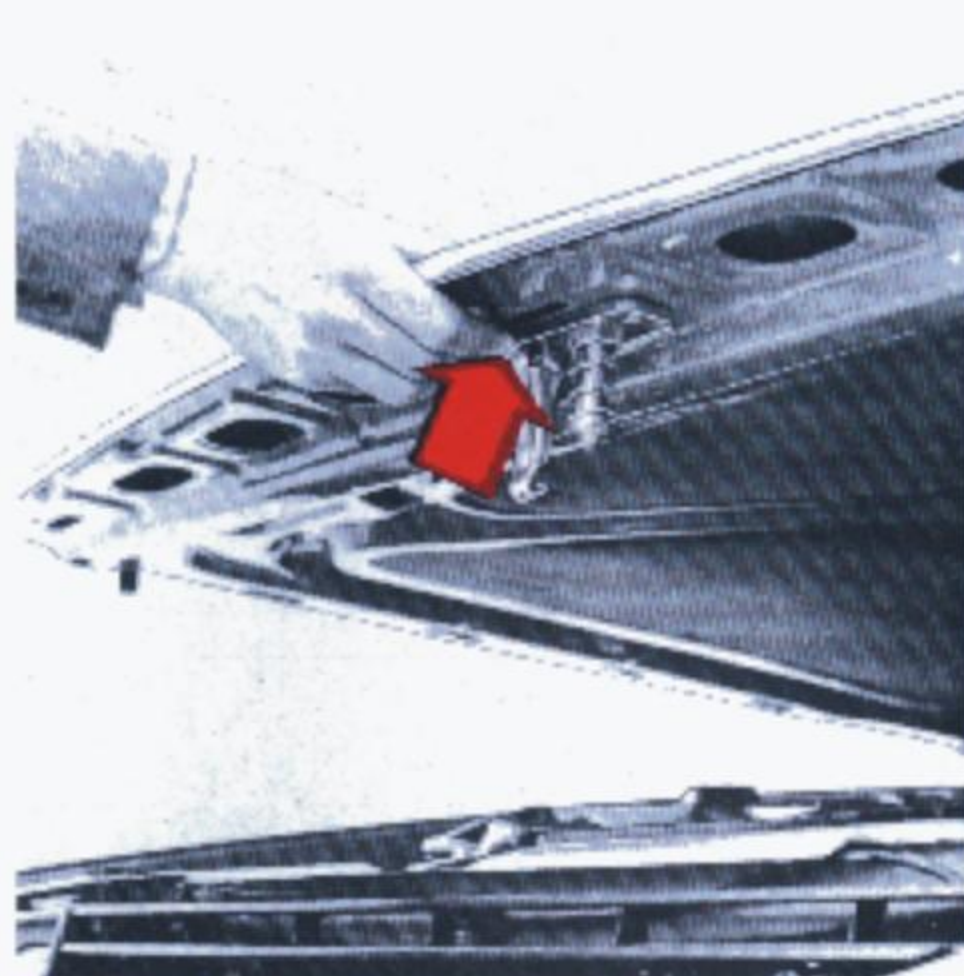

Lift up the front of the bonnet slightly and put your fingers under the front edge and press the safety catch upwards.

Open the bonnet.

Make sure it is properly fastened when you close it again.

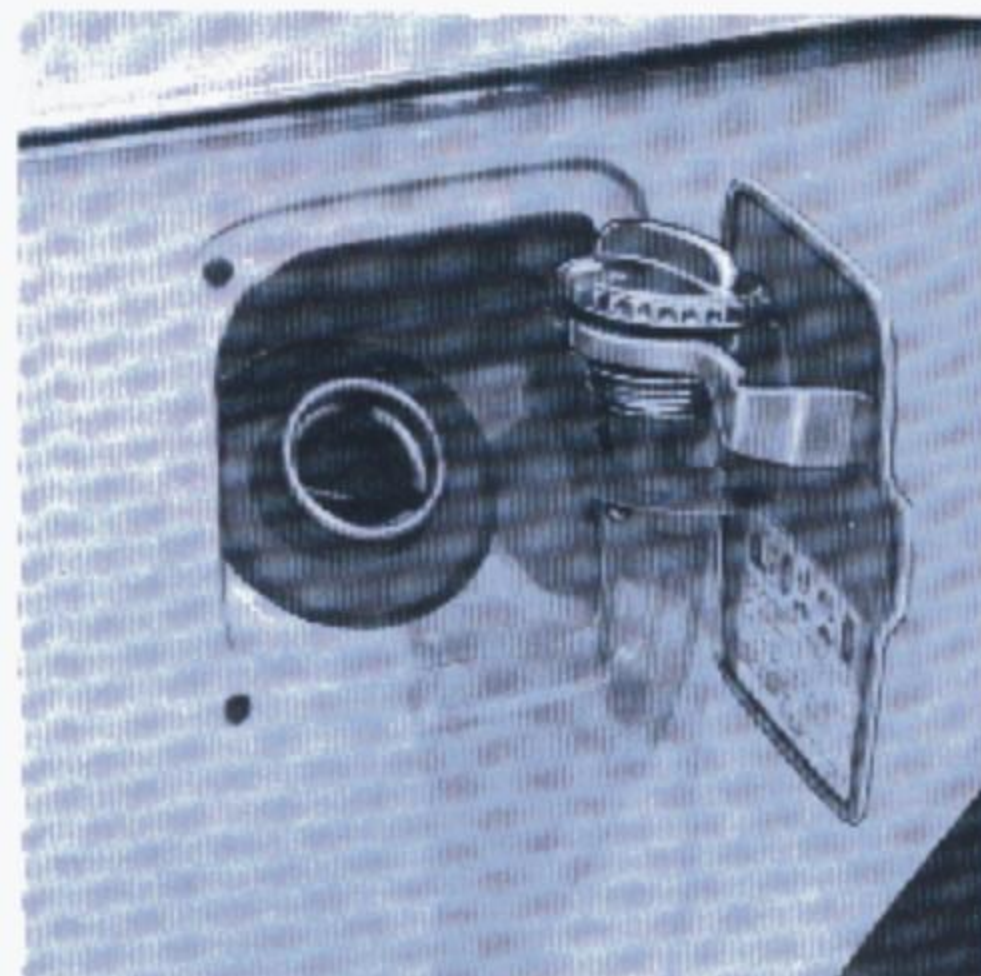

Tank filler cap

The tank filler cap is situated on the inside of the flap on the right-hand rear wing. The cap can be placed in the holder of the inside of the flap while refuelling.

A "wheezing" sound can be heard when removing the filler cap due to a certain overpressure in the fuel tank. This is quite normal and is not to be regarded as something dangerous.

When re-fitting the cap after filling the tanks, turn the cap until you hear a clicking sound. The correct octane will depend on the engine type, see page 78.

The fuel tank holds about 60 litres (13 UKgal).

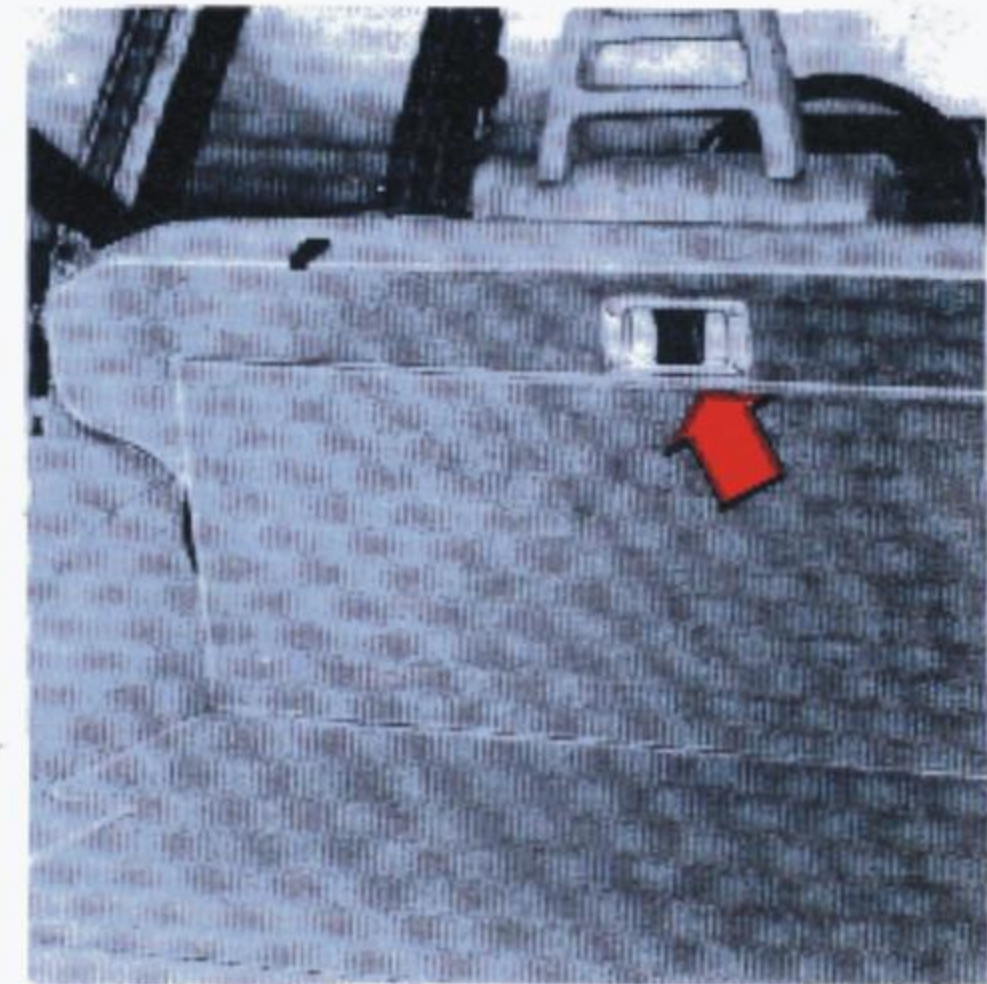
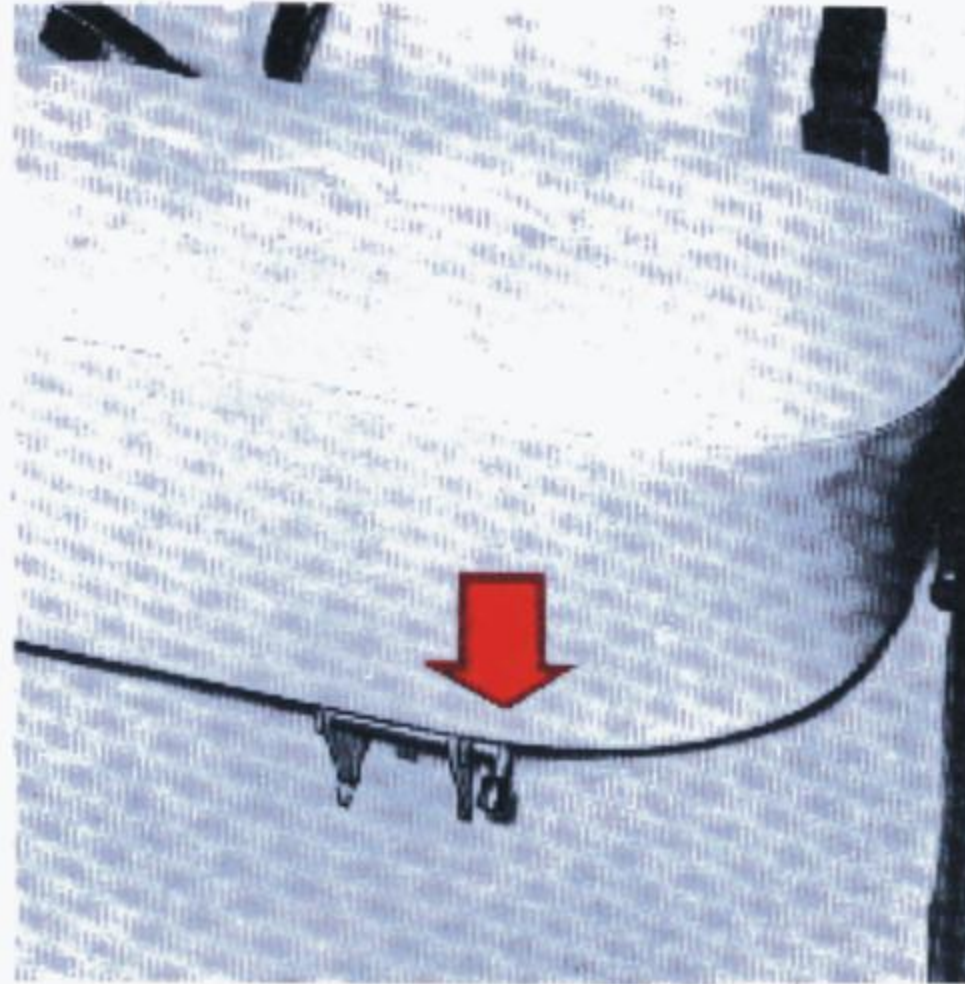

The 245 rear seat, cargo space and tailgate are described on pages 27, 28 and 29.

Folding up the rear seat 245

Push down **one** of the levers at the front of the cushion (one on each side). Take hold of the rear end of the cushion and tilt up towards the front seat backrest.

Move the handle on the rear seat backrest and fold down the backrest.

Make sure that all the seat belts are in their proper place when the rear seat is put back in position again.

Tailgate 245

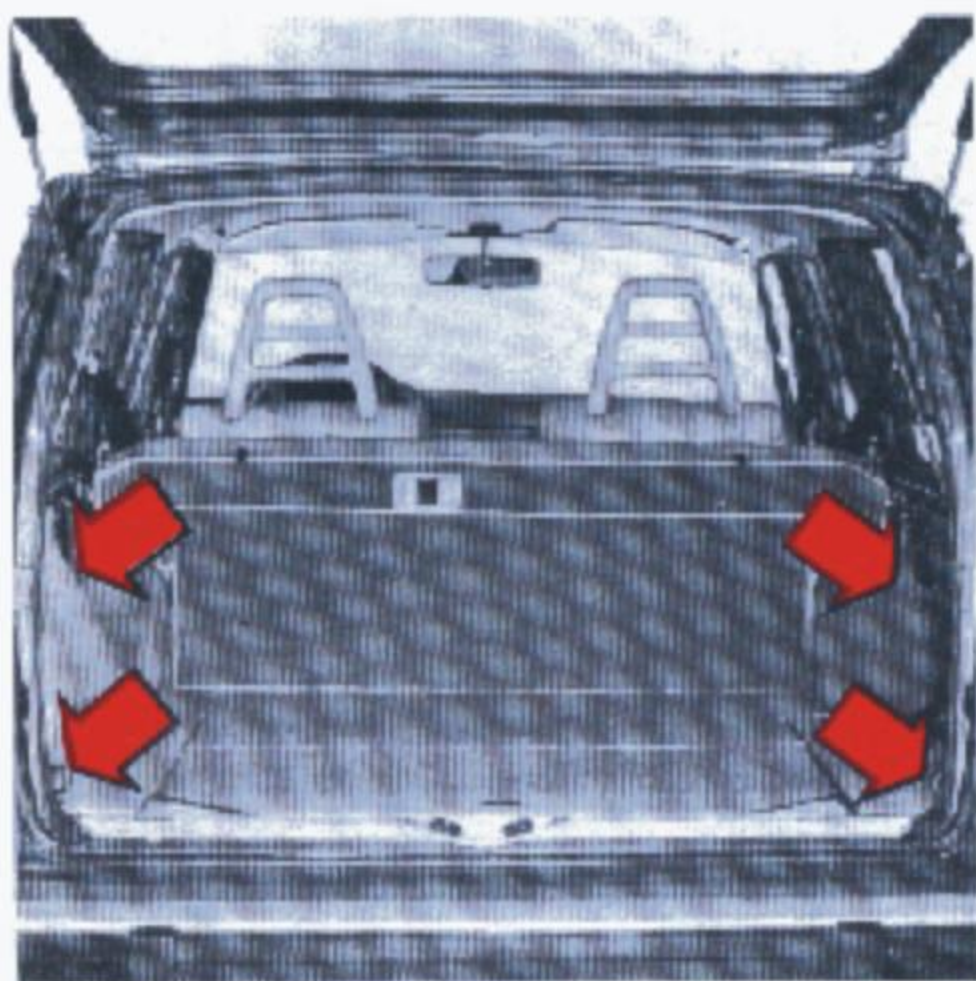

Cargo attachment eyelets

Six eyelets have been fitted to which ropes for holding down bulky loads can be attached – a safety measure designed to protect occupants from injury in the event of, e.g., abrupt braking. Four of these eyelets are shown on the illustration. The other two are situated underneath the rear seat cushion which can be tilted up. Your Volvo dealer can supply you with bands specially made to hold down your luggage, etc.

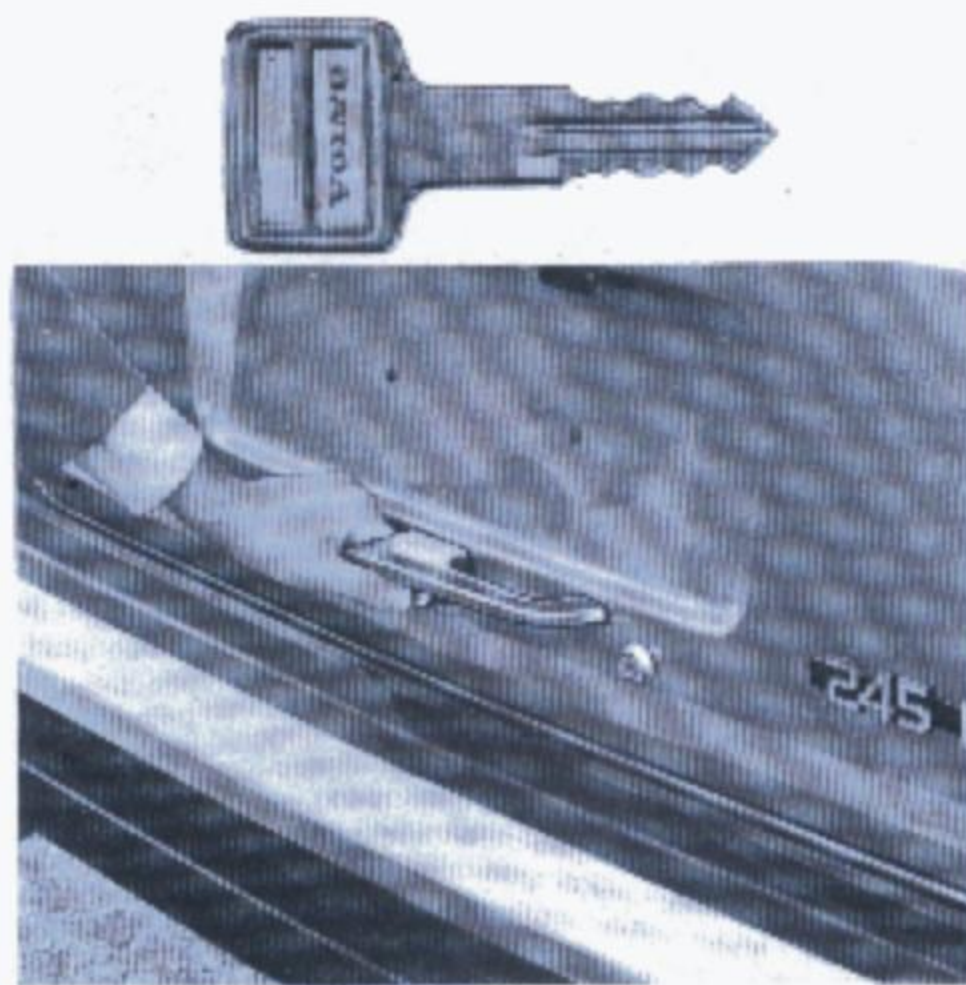

Opening from the outside

Open by pressing in the knob.

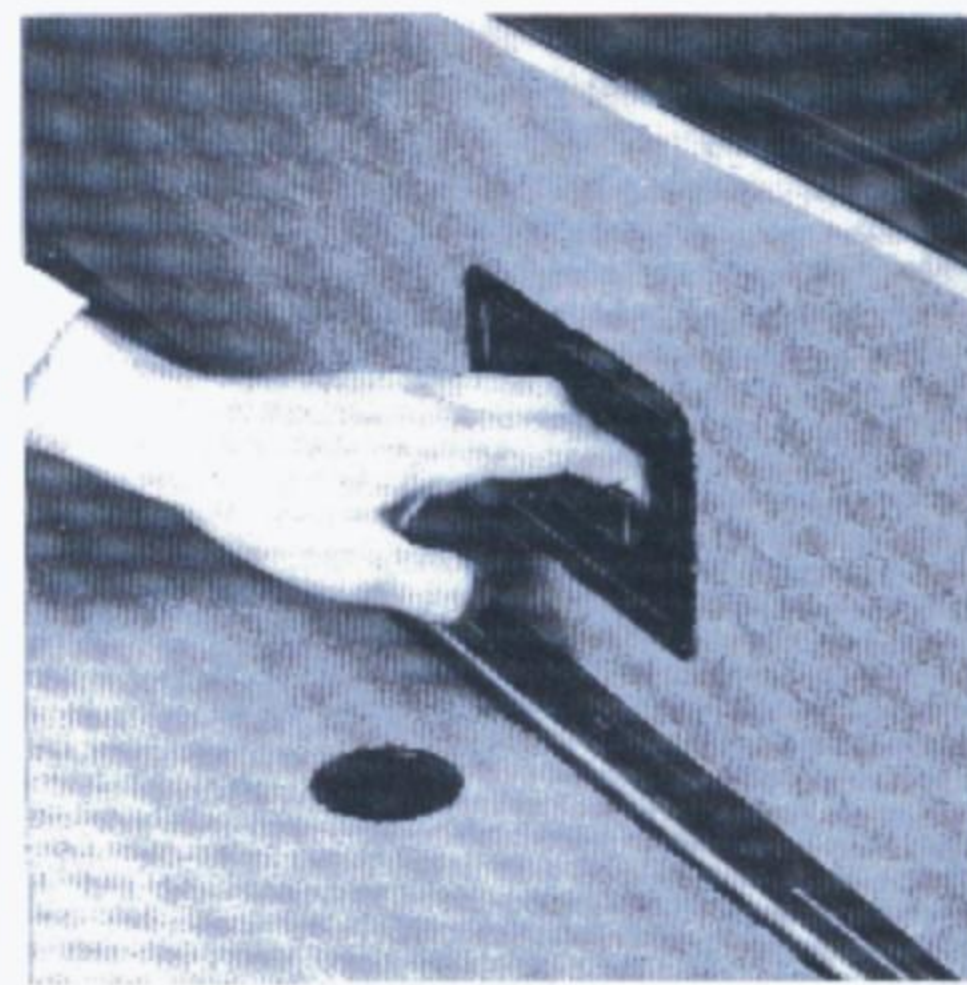

Opening from the inside

Pull out the handle at the bottom of the tailgate.

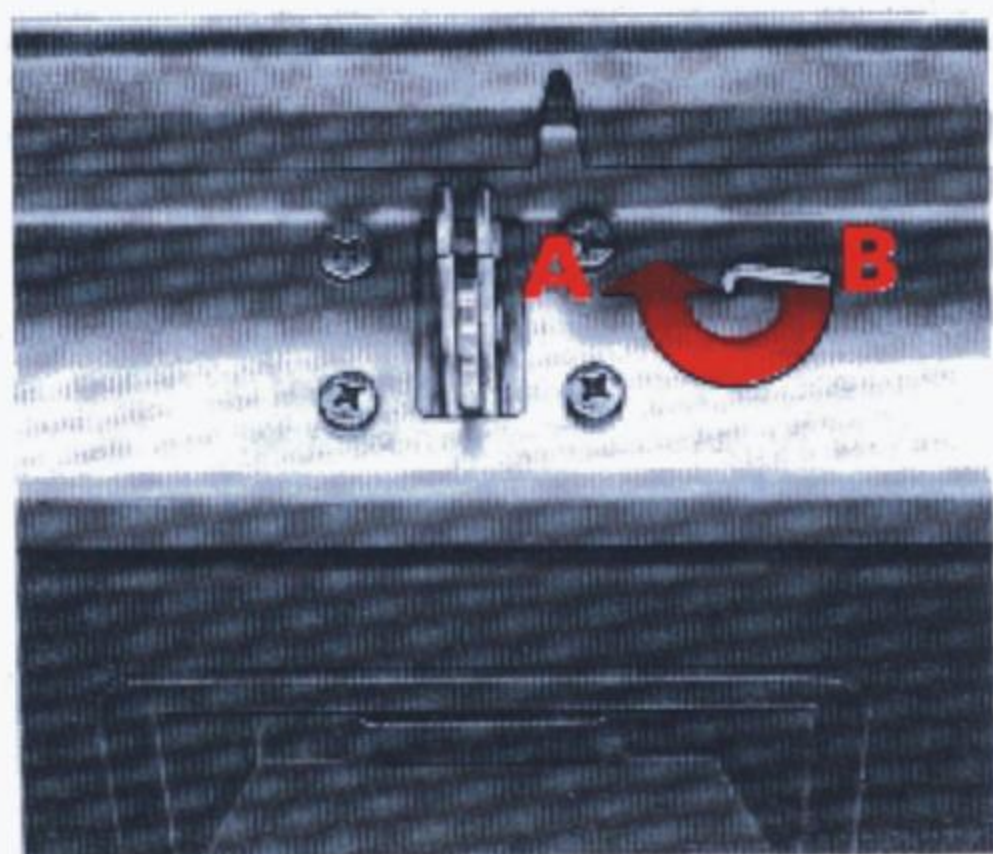

Safety latch

- A it is not possible to open the tailgate from the **inside**, only from the outside.
- B tailgate can be opened either from the inside or the outside.

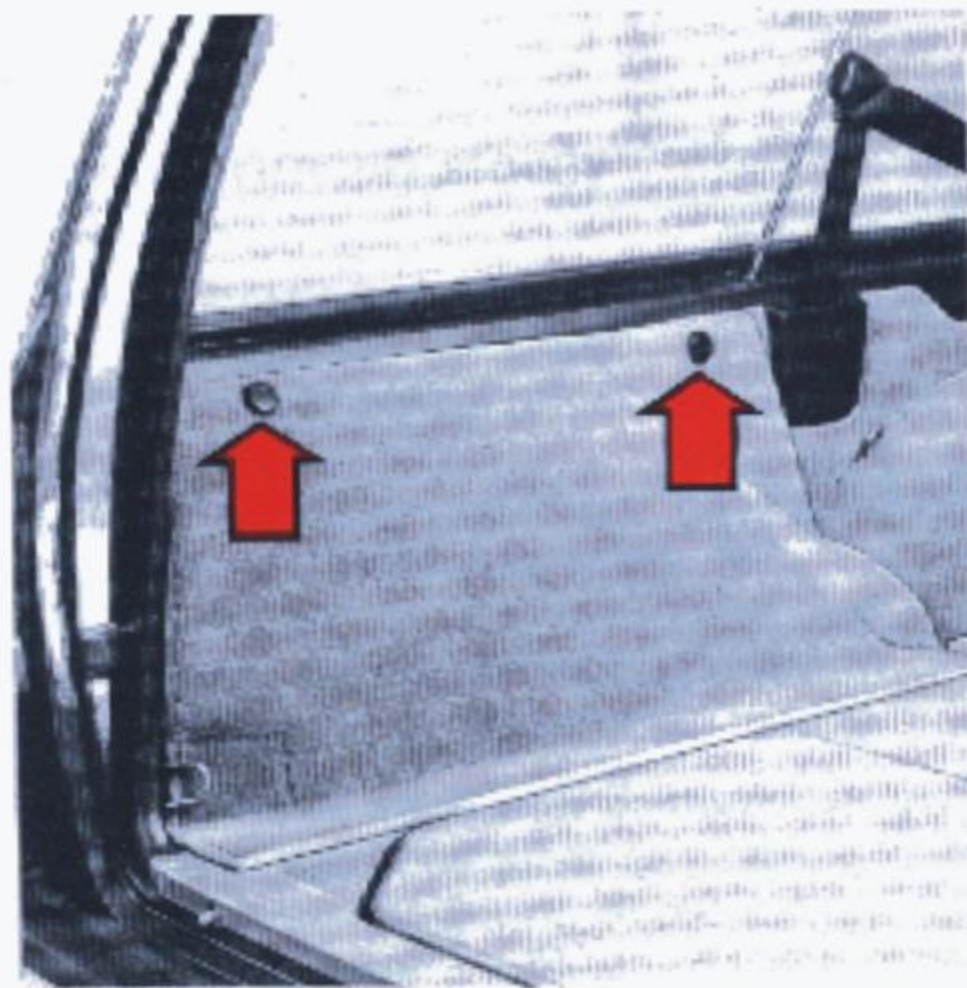

Spare wheel

Unscrew the two screws and lift off the cover to get at the spare wheel and jack.

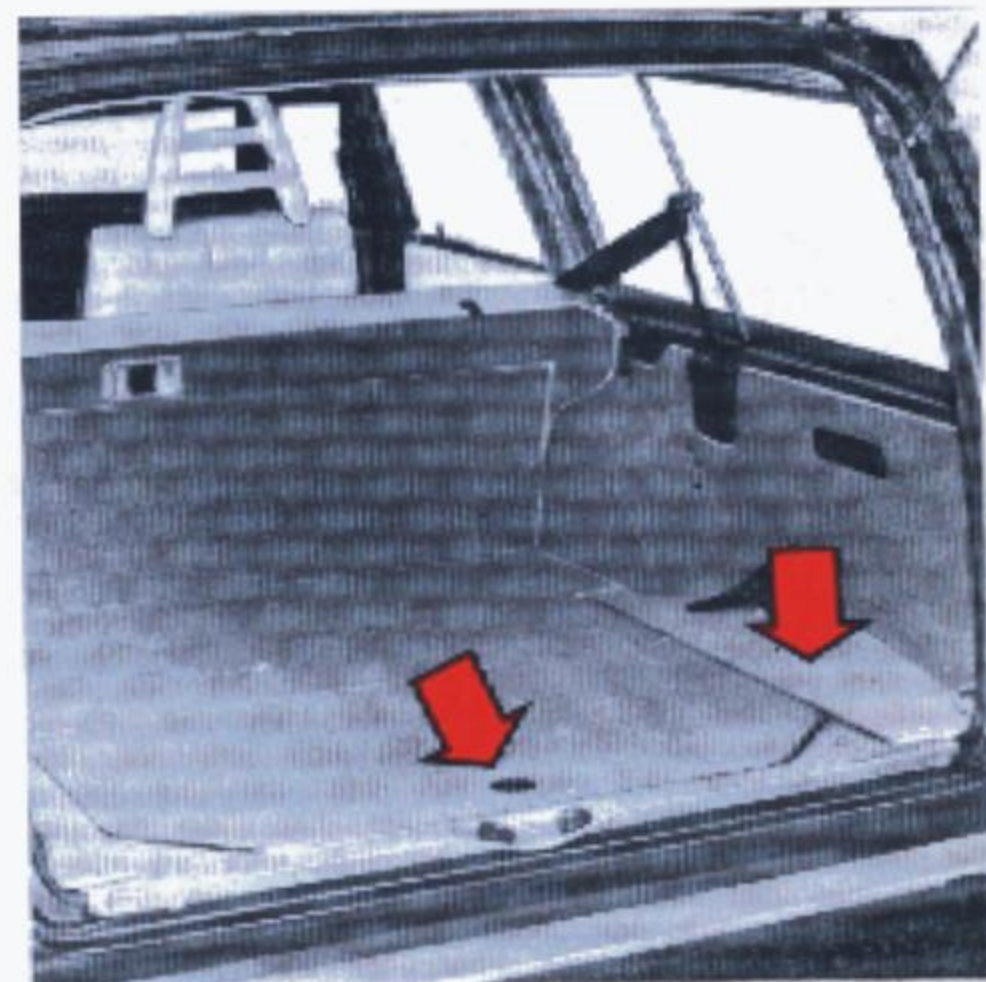

Extra stowage cavities

Two extra stowage cavities are situated under the load space floor: the small one on the right houses the fluid reservoir for the tailgate window washer. An extra seat, intended to be fitted in "back-to-front" in the load space on the 245 can be obtained from the Volvo dealer.

Presentation 2

DRIVING

Instruments, switches and controls 4

Instruments, indicator/warning lights, ignition switch/steering wheel lock, direction indicator stalk, headlight switch, panel illumination knob, windscreen wiper/wash, rear demist, hazard warning lights, clock, cigar lighter, ashtrays, parking brake, choke, heating and ventilation.

Interior details 18

Courtesy light, rear view mirrors, rear quarter-light, sun roof, seats, child safety, seat belts.

SERVICING

Volvo service, points to remember, engine compartment 40

Oils, fluids, lubrication and cooling systems 44

Engine, transmission, final drive, brakes, power-assisted steering, body lubrication, coolant, drive belts.

Electrical system 52

Changing bulbs, changing fuses.

Wheels and tyres 58

General advice, spare wheel, changing wheels.

SPECIFICATIONS

Index 83

Doors, locks, bonnet and boot lid 24

Doors and locks, boot lid, bonnet, tank filler cap.

Rear seat and rear cargo space 245 27

Starting and driving 30

Running-in, economic driving, starting the engine, manual gearbox, automatic transmission, towing, caravan, roof rack, points worth remembering.

Body care 64

Replacing windscreen and headlamp wiper blades, washing, polishing, waxing, rustproofing, cleaning upholstery, etc., touching-up damaged paintwork.

Cold weather and before a long-distance trip 70

Fault-tracing 72